

A Semicylindrical Capacitive Sensor With Interface Circuit Used for Flow Rate Measurement

Cheng-Ta Chiang, *Member, IEEE*, and Yu-Chung Huang

Abstract—In this paper, a semicylindrical capacitive sensor with an interface circuit used for flow rate measurement is proposed. The numerical analysis method to calculate the capacitance of the semicylindrical capacitive sensor is analyzed and discussed. The picofarad-range capacitive variation of the semicylindrical capacitive sensor can be detected and converted into voltage variation by the interface circuit. Besides, the interface circuit is compact enough to simplify the circuit complexity and could be easily implemented for flow rate measurement. All the functions of the capacitive sensing method of the semicylindrical capacitive sensor used for flow rate measurement are proved successfully through HSPICE simulation. Measurement results have successfully confirmed the correct functions and performance of the semicylindrical capacitive sensor with an interface circuit used for flow rate measurement, which ranges from 0.136 to 4.746 L/min, on the liquid crystal display panel coating machine.

Index Terms—Capacitive sensor, flow rate measurement, HSPICE, interface circuit, liquid crystal display (LCD), switched capacitor.

I. INTRODUCTION

RECENTLY, flow detection for process control has made important demands in the industry such as panel coating techniques in the optoelectronics industry and titrator developments in biotechnology. Generally, the methodologies for flow detection are distinguished according to the material types (gas or liquid), properties (electric conductivity, viscosity, and corrosiveness), and flow rate (slow or fast). Such traditional products to deal with flow detection such as differential-pressure flow meter [1], rotameter, positive-displacement (PD) flow meter, vortex flow meter [2], [3], electromagnetic flow meter [4], [5], ultrasonic flow meter [6]–[8], etc., have been built. However, the manufactured techniques and the cost of the present flow meters are quite high. Besides, the congenital limitations of flow meters should be noticed. For example, an electromagnetic flow meter is not suitable for use in nonelectric conductive materials. Hence, to overcome the limitations of material properties and simplify complicated detecting flow systems to decrease cost for the industry, an innovative flow measuring using the sensing techniques of the capacitive sensor has been inspired.

Manuscript received January 14, 2006; revised July 20, 2006. This work was supported by the National Science Council, Taiwan, under Contract NSC92-2218-E-009-011. The associate editor coordinating the review of this paper and approving it for publication was Dr. Ai-Qun Liu.

The authors are with the Measurement Techniques Laboratory, Department of Electronics Engineering and Institute of Electronics, National Chiao Tung University, Hsinchu 300, Taiwan, R.O.C. (e-mail: ctchiang23.ee90g@nctu.edu.tw).

Digital Object Identifier 10.1109/JSEN.2006.883847

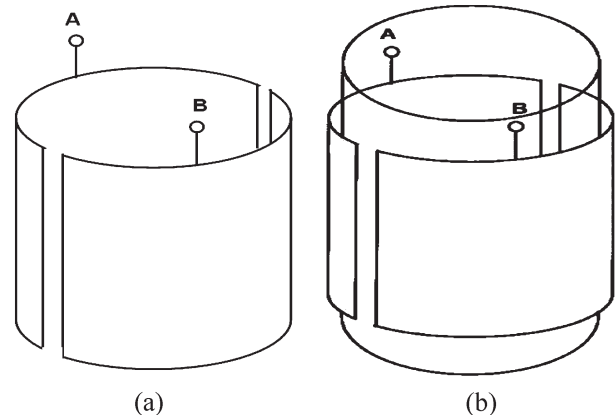

Fig. 1. Architecture of the semicylindrical capacitive sensor. (a) Without dielectric fluid. (b) With dielectric fluid.

Capacitive sensors have been used in various sensing applications, such as acceleration, force, pressure, dielectric properties, and displacement sensors [9], [10]. Among them, in comparison with the researches of parallel-plate capacitors, research into cylindrical capacitive sensors have been mainly focused on the analyses of properties, for example, the electrostatic forces of the charged coaxial cylindrical capacitor [11], [12] and nonlinear analysis of the cylindrical capacitive sensor [13]. Until now, no study has analyzed and discussed semicylindrical capacitive sensors used in fluidic sensing applications. Hence, differing from the structures of cylindrical capacitive sensors, a novel semicylindrical capacitive sensor is first investigated for fluidic measurement [14].

In this paper, a semicylindrical capacitive sensor with an interface circuit used for flow rate measurement has been proposed. The numerical analysis method used to calculate the capacitance of the semicylindrical capacitive sensor is analyzed and discussed. The picofarad-range capacitive variation of the semicylindrical capacitive sensor can be detected and converted into voltage variation by the interface circuit. Besides, the interface circuit is compact enough to simplify the circuit complexity and could be easily implemented for flow rate measurement. All the functions of the capacitive sensing method of the semicylindrical capacitive sensor used for flow rate measurement have been proved successfully through HSPICE simulation. Measurement results have successfully confirmed the correct functions and performance of the semicylindrical capacitive sensor with an interface circuit used for flow rate measurement on the liquid-crystal-display (LCD) panel coating machine.

Section II describes the capacitive sensing method to calculate the capacitance of the semicylindrical capacitive sensor.

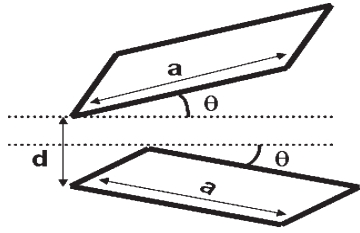

Fig. 2. Capacitive sensing method for the semicylindrical capacitive sensor.

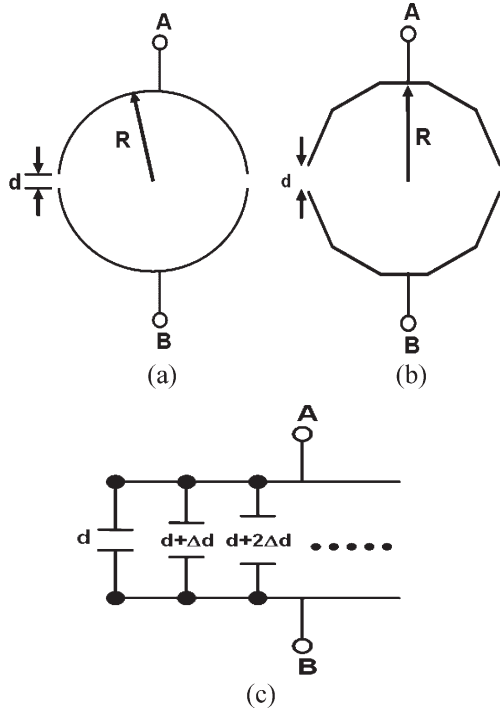

Fig. 3. (a) Top view of the semicylindrical capacitive sensor without dielectric fluid. (b) Approximate structure of the semicylindrical capacitive sensor for numerical analysis method. (c) Equivalent capacitors between A and B terminals.

Section III displays the architecture of the interface circuit and simulation results. Section IV presents the measurement results. Section V gives the conclusion and future works.

II. CAPACITIVE SENSING METHOD FOR SEMICYLINDRICAL CAPACITIVE SENSOR

Generally, to calculate the capacitance of capacitive sensors, Maxwell's equations relating electric and magnetic fields and charge density should be used. However, the analysis and calculation under such fields is quite difficult and complicated. By simplifying the complexity, electrostatic analysis, which is used to reduce the discovery of the complicated electric field produced by various charge distributions of materials with various dielectric constants, is rather suitable in calculating the capacitance of capacitive sensors. Thus, based on the concept of electrostatic analysis, the capacitive sensing method for this semicylindrical capacitive sensor is analyzed and discussed below.

Fig. 1(a) and (b) shows the architecture of the semicylindrical capacitive sensor without and with dielectric fluid. The semicylindrical capacitive sensor consists of two metal semi-

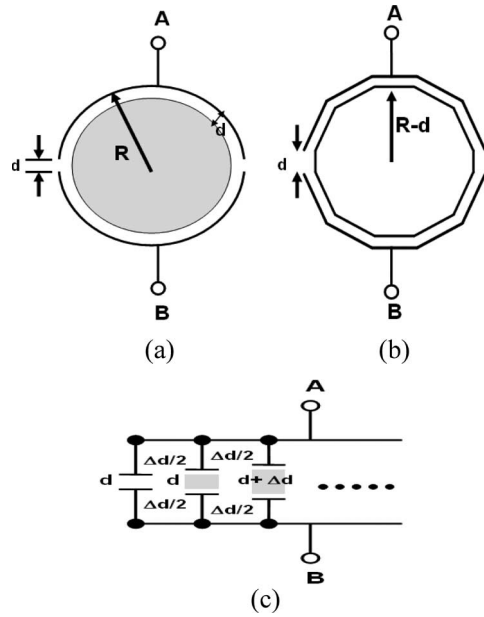

Fig. 4. (a) Top view of the semicylindrical capacitive sensor with dielectric fluid. (b) Approximate structure of the semicylindrical capacitive sensor for numerical analysis method. (c) Equivalent capacitors between A and B terminals.

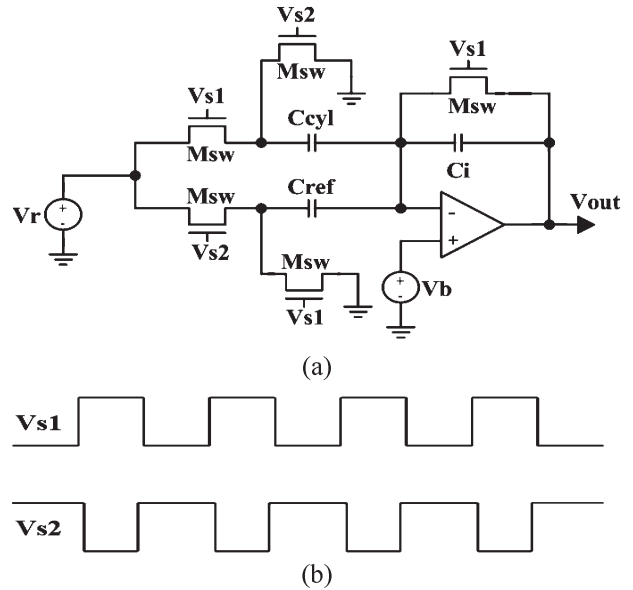

Fig. 5. (a) Interface circuit. (b) Timing diagram of Vs1 and Vs2 nonoverlapping two-phase clock cycles.

cylinders, which are separated by a gap distance. The dielectric material in Fig. 1(a) is air; thus, the dielectric constant ϵ_1 is equal to one. In Fig. 1(b), the dielectric constant ϵ_2 of the specified fluid is more than two.

First, the capacitance of the two unit metal plates should be analyzed and discussed. In Fig. 2, the capacitance is derived as

$$C = \int_0^a dc = \int_0^a \frac{\epsilon_0 * a * dx}{d + x\theta} = \frac{\epsilon_0 * \epsilon_1 * A}{d} * \left[1 - \frac{a\theta}{d} \right] \quad (1)$$

where ϵ_0 is the permittivity of free space of magnitude 8.85 (pF/m), ϵ_1 is the dielectric constant, A is the area of a

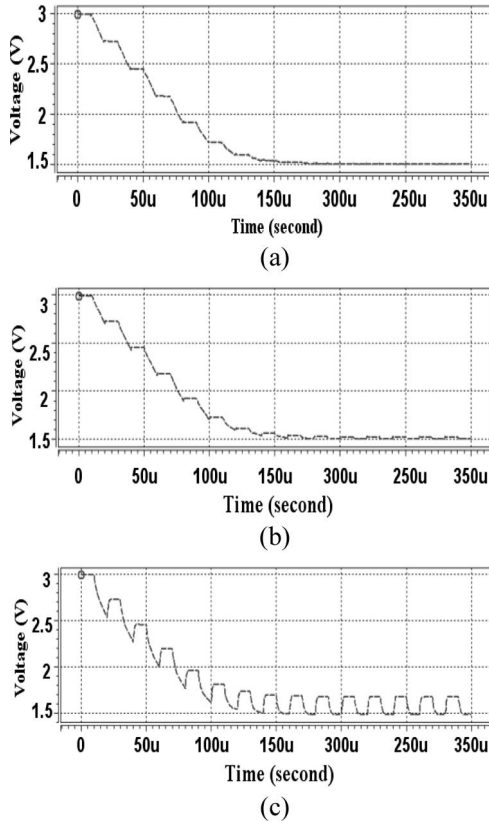

Fig. 6. Capacitor ratio $[(C_{cyl} - C_{ref})/C_i] = 0$. (b) Capacitor ratio $[(C_{cyl} - C_{ref})/C_i] = 0.01$. (c) Capacitor ratio $[(C_{cyl} - C_{ref})/C_i] = 0.1$ under $C_i = 1000$ pF, $C_{ref} = 20$ pF, and $C_{cyl} = 20, 30,$ and 120 pF, respectively.

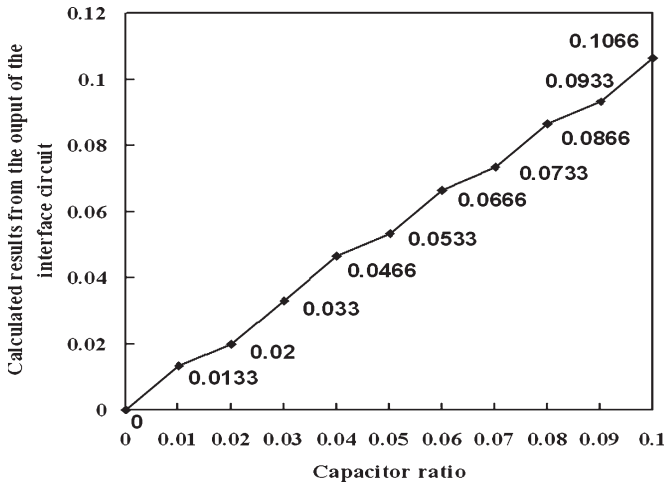

Fig. 7. Calculated results from the output of the interface circuit by performing (7) under $C_i = 1000$ pF, $C_{ref} = 20$ pF, and C_{cyl} sweeping from 20 to 120 pF.

unit metal plate, and d is the minimum gap distance. Therefore, if the cutting number of the semicylindrical capacitive sensor is large ($d \gg a\theta$), the capacitance in (1) can be approximated as

$$C \cong \left[\frac{\epsilon_0 * \epsilon_1 * A}{d} \right]. \tag{2}$$

Hence, it can be noticed that the minimum gap distance d of two unit metal plates will be the most important factor in the

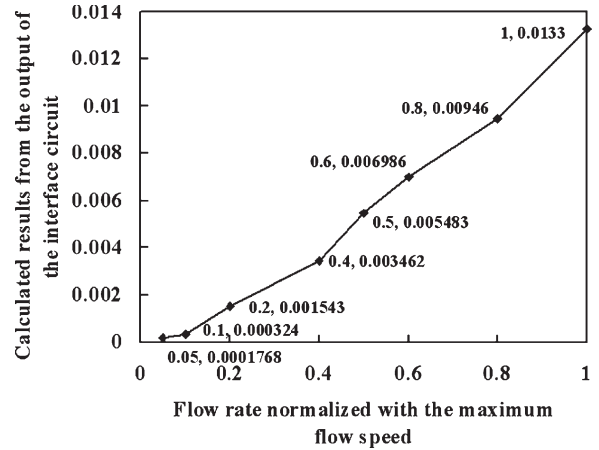

Fig. 8. Calculated results from the output of the interface circuit by performing (7) to simulate the flow rate measurement under varied flow rates, which ranges from 0.05 to 1, normalized with the maximum flow speed.

following numerical analysis of the semicylindrical capacitive sensor.

Fig. 3(a) displays the top view of the semicylindrical capacitive sensor without dielectric fluid. The two metal semicylinders have the radius R and a minimum gap distance d . The numerical analysis method is applied to approximate the capacitance of the semicylindrical capacitive sensor. The structure of the semicylindrical capacitive sensor for the numerical analysis method is shown in Fig. 3(b). Based on the structure of Fig. 2, each individual capacitor within two metal semicylinders could be modified as each pairs of two unit metal plates with an increment Δd distance. Hence, all the equivalent capacitors could be parallelly structured between A and B terminals, as presented in Fig. 3(c). Following (2), the capacitance of two metal semicylinders without dielectric fluid can be expressed as

$$\begin{aligned}
 C_0 &= \sum_{i=0}^n C_i(d + i\Delta d) \\
 &= 2 * \epsilon_0 * \epsilon_1 * A \\
 &\quad * \left[\frac{1}{d} + \frac{1}{d + \Delta d} + \frac{1}{d + 2\Delta d} + \dots + \frac{1}{d + (n - 1)d} \right] \\
 &\quad + \frac{\epsilon_0 * \epsilon_1 * A}{2R} \\
 &= \sum_{i=1}^n 2 * \epsilon_0 * \epsilon_1 * A * \left[\frac{1}{d + (i - 1)\Delta d} \right] \\
 &\quad + \frac{\epsilon_0 * \epsilon_1 * A}{2R} \tag{3}
 \end{aligned}$$

where ϵ_0 is the permittivity of free space of magnitude 8.85 (pF/m), ϵ_1 is the dielectric constant of air, n is the cutting number for numerical analysis, A is the unit area of metal semicylinders, d is the minimum gap distance, and Δd is an increment distance. Similarly, Fig. 4 displays the structure of the semicylindrical capacitive sensor with dielectric fluid for the numerical analysis method. Based on (3), the

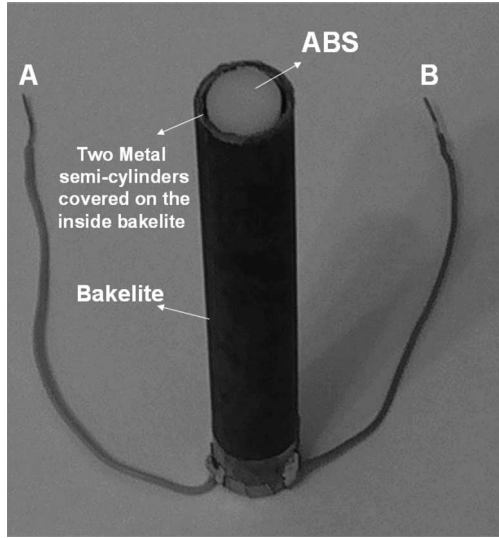

Fig. 9. Manufactured structure of the semicylindrical capacitive sensor. The material of the fluid is acrylonitrile butadiene styrene (ABS). Two metal semicylinders are covered on the inside bakelite. The maximum radius of the fluid is 5 mm, and the minimum gap distance of two metal semicylinders is 0.2 mm.

capacitance of two metal semicylinders with dielectric fluid can be written as

$$\begin{aligned}
 C_1 &= \sum_{j=0}^n C_j(d+j\Delta d) \\
 &= 2 * \epsilon_0 * A \\
 &\quad * \left[\frac{1}{\epsilon_1} + \frac{1}{\epsilon_1 + \frac{\Delta d}{\epsilon_2}} + \frac{1}{\epsilon_1 + \frac{2\Delta d}{\epsilon_2}} + \dots + \frac{1}{\epsilon_1 + \frac{(n-1)\Delta d}{\epsilon_2}} \right] \\
 &\quad + \frac{\epsilon_0 * A}{\frac{\Delta d}{\epsilon_1} + \frac{2R-2d}{\epsilon_2}} \\
 &= \sum_{j=1}^n 2 * \epsilon_0 * A * \left[\frac{1}{\epsilon_1} + \frac{1}{\epsilon_1 + \frac{(j-1)\Delta d}{\epsilon_2}} \right] \\
 &\quad + \frac{\epsilon_0 * A}{\frac{\Delta d}{\epsilon_1} + \frac{2[R-(d+n\Delta d)]}{\epsilon_2}} \tag{4}
 \end{aligned}$$

where ϵ_2 is the dielectric constant of the specified fluid. Therefore, as analyzed in (3) and (4), the capacitance of the semicylindrical capacitive sensor varies when the dielectric fluid flows through these two metal semicylinders. Moreover, according to the definition of the flow rate Q , Q can be expressed by

$$\text{Flow rate } (Q) \text{ (L/ min)} = \frac{\Delta V}{\Delta t} \approx \frac{\pi * h * r^2}{\Delta t} \tag{5}$$

where r and h are the fluidic radius and the fluidic length flowing through the two metal semicylinders, respectively. Combined with (4) and (5), the flow rate Q is modified as

$$\begin{aligned}
 \text{Flow rate } (Q) \text{ (L/ min)} \\
 &= \frac{\Delta V}{\Delta t} \propto \frac{h * \sum_{j=0}^n C_j(d+j\Delta d)}{\Delta t}. \tag{6}
 \end{aligned}$$

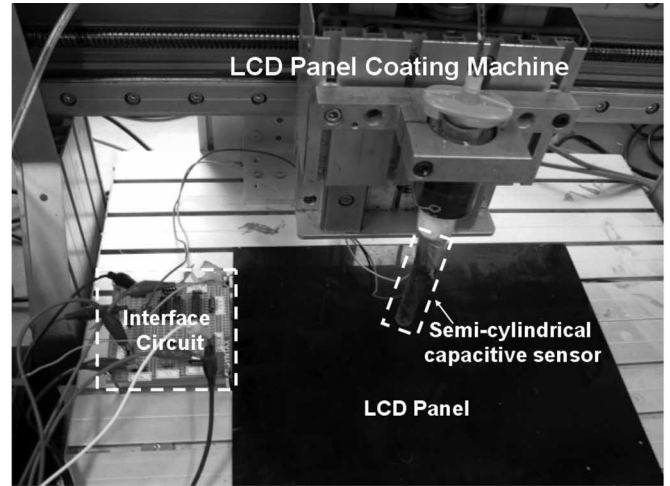

(a)

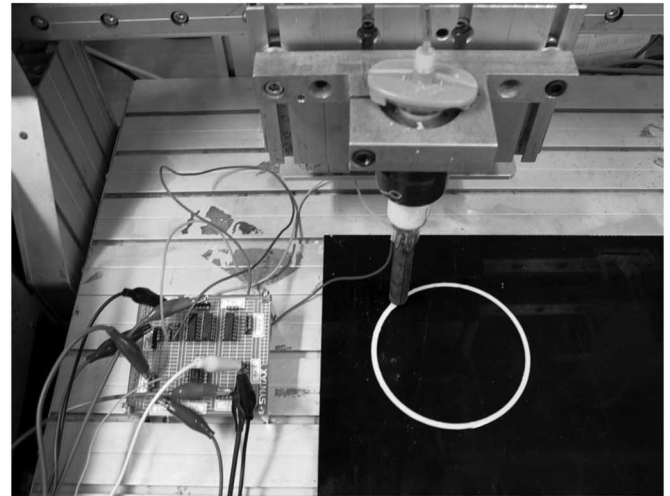

(b)

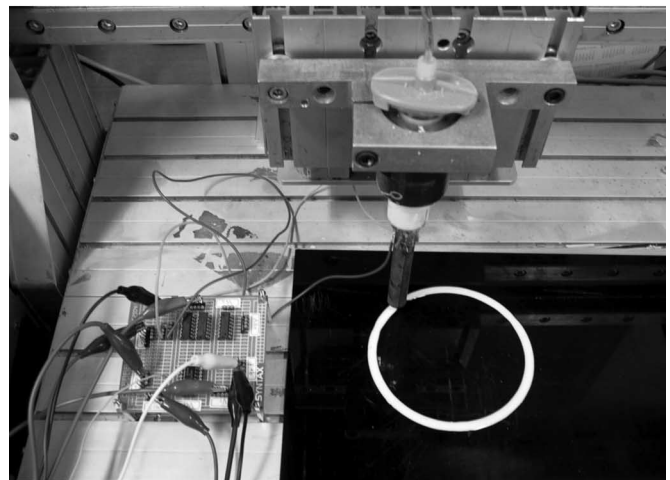

(c)

Fig. 10. Photographs of (a) semicylindrical capacitive sensor with an interface circuit applied to the LCD panel coating machine. (b) Under the ABS flow rate of 1.434 L/min. (c) Under a flow rate of 4.134 L/min.

Therefore, the capacitive variation $\sum_{j=0}^n C_j(d+j\Delta d)$ has a proportional relationship with the flow rate Q . All the simulations used to verify the capacitive sensing method of the

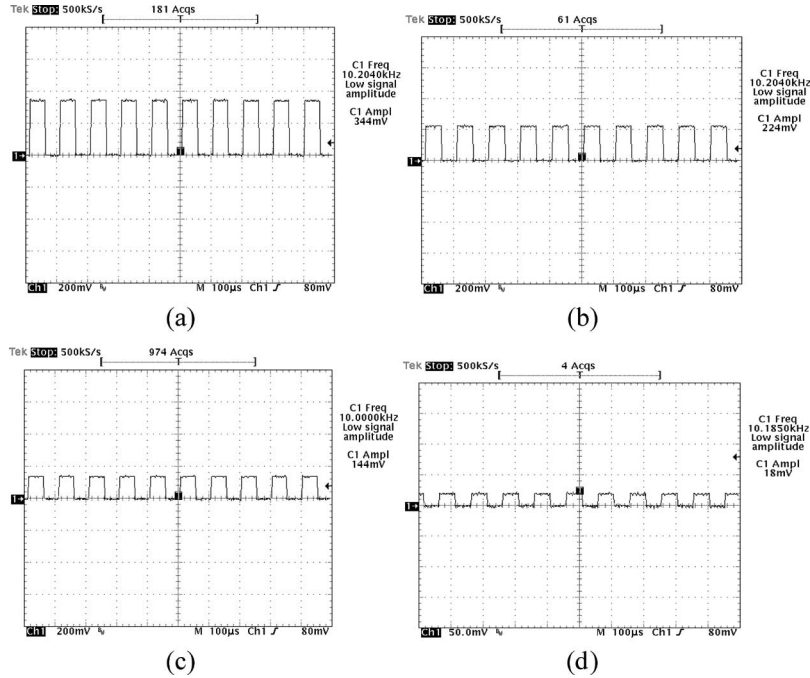

Fig. 11. Measured results of the interface circuit under the ABS flow rates. (a) 4.746 L/min. (b) 3.338 L/min. (c) 1.434 L/min. (d) 0.136 L/min.

semicylindrical capacitive sensor for flow rate measurement are analyzed in Section III.

III. INTERFACE CIRCUIT AND SIMULATION RESULTS

Following the switched-capacitor techniques, the compact interface circuit and timing diagram are shown in Fig. 5(a) and (b). This circuit applies the charge redistribution method. The signals Vs1 and Vs2 are nonoverlapping two-phase clock cycles. When Vs1 signal is logic high, the total charge is stored on the semicylindrical capacitor Ccyl. The output voltage of operational amplifier is fixed at controlling voltage Vb. In another phase, the same reference dc voltage Vr charges the reference capacitor Cref. Besides, the difference in charge between two phases will be stored on the capacitor Ci. Hence, the capacitor ratio (Ccyl – Cref)/Ci is derived as

$$\frac{C_{cyl} - C_{ref}}{C_i} = \frac{V_{out} - V_b}{V_r - V_b}. \tag{7}$$

All simulation results are based upon the device parameters of 0.35-µm 2P4M CMOS technology with a 3-V power supply. The two-phase clock cycles Vs1 and Vs2 are both operated at 50 kHz to perform the functions of an interface circuit. Then, the output of the interface circuit is used to calculate the capacitor ratio. As shown in Fig. 6(a)–(c), this interface circuit has performs well in converting picofarad-range capacitive variation into voltage variation. These output voltages are 1.5, 1.53, and 1.67 V, respectively. All the calculated results, by performing (7), are plotted in Fig. 7.

MATLAB and HSPICE software are performed (3)–(7) to simulate the varied flow rate measurement. Taking the simulation under the maximum flow rate as an example, the capacitors C0 and C1, by performing the MATLAB, are calculated as

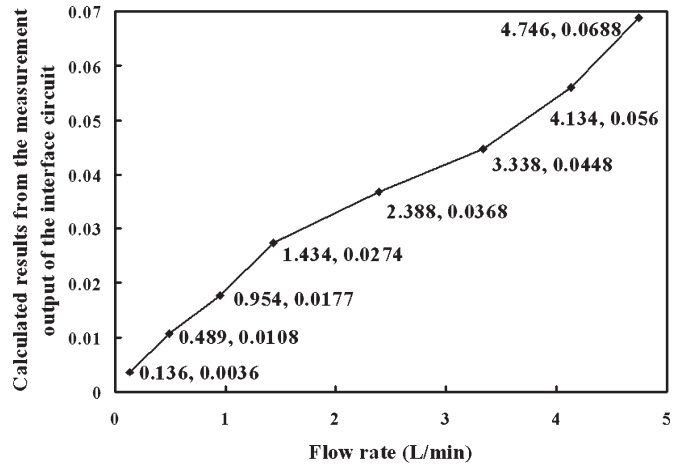

Fig. 12. Calculated results from the measurement output of the interface circuit by performing (7) under varied ABS flow rates, which ranges from 0.136 to 4.746 L/min. The bigger capacitance is expected to increase the ABS flow rate, and measured results are observed.

13.7382 and 24.256 pF. Then, to verify through HSPICE, these two capacitors C0 and C1 are replaced as capacitor Cref and Ccyl, respectively. After simulation, the output voltage of the interface circuit is 1.52 V, and the calculated result, by performing (7), is 0.0133. Similarly, under other flow rates, simulations are also performed in the same way. Finally, all the calculated results under varied flow rates, which ranges from 0.05 to 1, normalized with the maximum flow speed, are shown in Fig. 8. These simulation results above have successfully confirmed the correct functions of the capacitive sensing method of the semicylindrical capacitive sensor and performance of the semicylindrical capacitive sensor with an interface circuit used for flow rate measurement.

TABLE I
SUMMARY OF THE CHARACTERISTICS OF THE SEMICYLINDRICAL CAPACITIVE SENSOR WITH
AN INTERFACE CIRCUIT USED FOR FLOW RATE MEASUREMENT

Sensor geometry	Semi-cylindrical type
Methodology of the flow meter	Capacitive sensing technique
Methodology of the interface circuit	Switched-Capacitor technique
Capacitor resolution	pF-range
Testing bench	LCD panel coating machine
Fluid	Acrylonitrile, Butadiene, Styrene (ABS)
Detecting range of the ABS flow rate	0.136 to 4.746 L/min
Applying market	Optoelectronics industry

IV. MEASUREMENT RESULTS

Fig. 9 shows a photograph of the manufactured structure of the semicylindrical capacitive sensor. The material of fluid is acrylonitrile butadiene styrene (ABS). Two metal semicylinders are covered on the inside bakelite. The maximum radius of the fluid is 5 mm, and the minimum gap distance of two metal semicylinders is 0.2 mm. Moreover, a prototype based on the circuit shown in Fig. 5 has been built. The switches and an op-amp are implemented with analog bilateral switches CD4066 and LF411, respectively. The two nonoverlapping phase clock cycles are implemented with some gates. Fig. 10 shows the photographs of a set of the semicylindrical capacitive sensor with an interface circuit applied to the LCD panel coating machine. The head of the ABS container is connected to the air compressor through a soft pipe. The air compressor and the movement of the LCD panel coating machine are precisely controlled by the mainframe of the factory. Moreover, the ABS flow rate can be known from the exclusive lookup table recorded on the mainframe, which is listed in the scale of pounds per square inch for the air compressor versus the scale of liter per minute for the ABS flowing through the container. Therefore, according to the lookup table, the ABS flow rate of the LCD panel coating machine could be precisely adjusted by the mainframe. Besides, by controlling the air compressor cooperating with the mainframe, the ABS can uniformly flow on the LCD panel, and the viscosity property of the ABS can also be overcome, as shown in Fig. 10(b) and (c). Fig. 11 displays the oscilloscope traces of the output voltage of the interface circuit under the ABS flow rates: Fig. 11(a) at 4.746 L/min; Fig. 11(b) at 3.338 L/min; Fig. 11(c) at 1.434 L/min; and Fig. 11(d) at 0.136 L/min. Hence, according to the measurement output of the interface circuit, all the calculated results, by performing (7), are plotted in Fig. 12. The varied ABS flow rates range from 0.136 to 4.746 L/min. As discussed in Section II, the bigger capacitance is expected to increase the ABS flow rate, and measured results are observed. Hence, by using the novel flow measuring techniques on the LCD panel coating machine, the mainframe can periodically monitor and immediately adjust the ABS flow rate according to the calculated results. Measurement results have successfully confirmed the correct functions and performance of the semicylindrical capacitive sensor with an interface circuit used for flow rate measurement on the LCD panel coating machine. The characteristics of the semicylindri-

cal capacitive sensor with an interface circuit used for flow rate measurement are summarized in Table I.

V. CONCLUSION

A semicylindrical capacitive sensor with an interface circuit used for flow rate measurement is newly proposed. The numerical analysis method used to calculate the capacitance of the semicylindrical capacitive sensor is analyzed and discussed. The picofarad-range capacitive variation of the semicylindrical capacitive sensor can be detected and converted into voltage variation by the interface circuit. Besides, the interface circuit is compact enough to simplify the circuit complexity and could easily be implemented for flow rate measurement. All the functions of the capacitive sensing method of the semicylindrical capacitive sensor and performance of the semicylindrical capacitive sensor with an interface circuit used for flow rate measurement are successfully verified. In future research, this semicylindrical capacitive sensor with an interface circuit will be adaptively adjusted according to the desired applications, for example, applied in the medical instrumentation systems of the intravenous drip.

ACKNOWLEDGMENT

The authors would like to thank Chi-Mei Corporation for their support in this paper.

REFERENCES

- [1] J. Q. Zhang and Y. Yan, "A self-validating differential-pressure flow sensor," in *Proc. IEEE IMTC*, May 2001, vol. 2, pp. 1227–1230.
- [2] C. Filips and V. H. Hans, "Comparison of analogous and digital demodulation methods of modulated ultrasonic signals in vortex flow metering," in *Proc. IEEE IMTC*, May 2002, vol. 2, pp. 1657–1660.
- [3] V. H. Hans, "New aspects of the arrangement and geometry of bluff bodies in ultrasonic vortex flow meters," in *Proc. IEEE IMTC*, May 2002, vol. 2, pp. 1661–1664.
- [4] A. Michalski and S. Wincenciak, "Method of optimization of primary transducer for electromagnetic flow meter," in *Proc. IEEE IMTC*, Jun. 1996, vol. 2, pp. 1350–1353.
- [5] A. Michalski, J. Starzynski, and S. Wincenciak, "Eliminating short ending effects in the primary transducer of electromagnetic flow meters," *IEEE Trans. Magn.*, vol. 39, no. 2, pp. 1035–1039, Mar. 2003.
- [6] H. B. Nemade, T. Anjaneyulu, and P. C. Pandey, "Sensing turbulence transit time by pulsed ultrasound for single-phase fluid flow measurement," *IEEE Trans. Instrum. Meas.*, vol. 46, no. 1, pp. 265–269, Feb. 1998.
- [7] V. Pavlovic, M. Stojcev, B. Dimitrijevic, L. Golubovic, M. Zivkovic, and L. Stankovic, "Ultrasonic pulse-phase method applied in fluid flow measurements," *Proc. Inst. Electr. Eng.—Sci., Meas. and Technol.*, vol. 143, no. 5, pp. 327–333, Sep. 1996.

- [8] T. Vontz and V. Magori, "An ultrasonic flow meter for industrial applications using a helical sound path," in *Proc. IEEE Ultrason. Symp.*, Nov. 1996, vol. 2, pp. 1047–1050.
- [9] T. N. Toth and G. C. M. Meijer, "A low-cost smart capacitive position sensor," *IEEE Trans. Instrum. Meas.*, vol. 41, no. 6, pp. 1041–1044, Dec. 1992.
- [10] L. K. Baxter, *Capacitive Sensors Design and Applications*. New York: IEEE Press, 1997.
- [11] Y. S. Ku, "Developing an axisymmetric parametric model for an electrostatic force balance," *Meas. Sci. Technol.*, vol. 15, no. 1, pp. 267–270, Jan. 2004.
- [12] —, "Optimization of axisymmetric parametric model for electrostatic force balance," *Meas. Sci. Technol.*, vol. 15, no. 10, pp. 2108–2112, Oct. 2004.
- [13] H. J. Ahn, I. H. Kim, and D. C. Han, "Nonlinear analysis of cylindrical capacitive sensor," *Meas. Sci. Technol.*, vol. 16, no. 3, pp. 699–706, Mar. 2005.
- [14] C.-T. Chiang and Y.-C. Huang, "A semi-cylindrical capacitive sensor with interface circuit using for fluidic measuring," in *Proc. IEEE IMTC*, Apr. 2006, pp. 2318–2322.

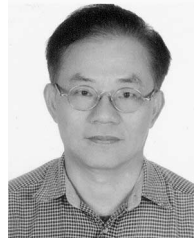

Yu-Chung Huang received the M.S. degree in electrical engineering and the Ph.D. degree in process engineering from Technology University of Berlin, Berlin, Germany, in 1982 and 1985, respectively.

Since 1985, he has been a Professor with the Department of Electronics, National Chiao Tung University, Hsinchu, Taiwan, R.O.C. His research interests are sensors and measuring technologies.

Prof. Huang is a member of the Committee of the Chinese Metrology Society and the Micromechanical Science Institute, China.



Cheng-Ta Chiang (S'00–M'05) was born in Taiwan, R.O.C., in 1977. He received the B.S. degree in electronics engineering from Chung-Yuan Christian University, Chung-Li, Taiwan, in 1999 and the M.S. degree in biomedical engineering from National Cheng-Kung University, Tainan, Taiwan, in 2001. He is currently working toward the Ph.D. degree at the Institute of Electronics, National Chiao-Tung University, Hsinchu, Taiwan.

His main research interests have been with analog integrated circuits, biomedical electronics, neuro-morphic vision chips, and sensor signal conditioning.

Mr. Chiang received the visiting scholar appointment for the period October 1, 2004–November 30, 2005, with the Department of Electrical and Computer Engineering, The Johns Hopkins University, Baltimore, MD. He has been selected to be included in the *Marquis Who's Who in Science and Engineering*, 9th ed., 2006–2007.