

Connecting interface for modularization of digital microfluidics

Hanping Yang^a, Shih-Kang Fan^b, Wensyang Hsu^{*a}

^aDept. of Mechanical Engineering, National Chiao Tung Univ. , 1001 Ta Hsueh Rd. , Hsinchu, Taiwan

^bInstitute of Nanotechnology, National Chiao Tung Univ. , 1001 Ta Hsueh Rd. , Hsinchu, Taiwan

ABSTRACT

Here, interconnection technique to link digital microfluidic chips is proposed. Three kinds of digital microfluidic modules with connecting interface, including flexible module and two types of connector modules, are designed and fabricated. Since these modules are fabricated on a compliant polymer-based substrate (ITO PET), chip-to-chip droplet transportation even at different planes can be achieved by the proposed technique. A low-temperature fabrication process is developed for the polymer substrates, where the SU-8 acts as the insulator. Droplet transportation through electrowetting on curved surface is confirmed by testing on the bended flexible modules with different curvatures from 0 to 0.06 mm^{-1} at around 70 V_{AC} . Then the droplet transportations between flexible and connector modules are investigated. It is found that the gap size between two modules and the sidewall profiles at interface affect the droplet transportation directly. For the gap size around $50 \mu\text{m}$ with a smooth perpendicular sidewall profile, 80 V_{AC} is shown to actuate droplet of $1.5 \mu\text{l}$, $2.5 \mu\text{l}$, or $3.5 \mu\text{l}$ to cross over the interface successfully.

Key words: digital microfluidics, electrowetting, flexible, connector.

1. Introduction

Microfluidic chips for liquid handling have been extensively investigated recently due to the great demands on reducing device sizes for chemical analysis and biomedical diagnosis [1-3]. In order to fulfill the need in biochemical analysis, the device often has to integrate other components beside the microfluidic part, such as heaters, mixers, and filters [4-6]. However, with more components expected in the device to provide more complicated functions, it could be a challenge to fabricate the whole device on a single chip.

One way to make a complicated device is to assemble several microchips with different functional units, including the working fluid, via connectors. For microfluidic chips with continuous flow, several methods have been proposed for the connection of microfluidic components [7]. For example, the wells method [8-10], the structure was simple, but manual loading was required. Integrated interconnects [11-13] were leak-proof; however, complicated fabrication and

* whsu@mail.nctu.edu.tw; phone 886-3-5712121ext55111; fax 886-3-5720634

dead volume should be considered. In general, structure complexity, leakage, dead volume, and reusability are design issues for the connecting technique in continuous flow system.

For digital microfluidic actuations, electrowetting on dielectric (EWOD) [14-15] is one of the mechanisms to drive droplets, which has advantages when the size of the droplet shrinks down for increased surface to volume ratio. Most of EWOD chips were fabricated on ITO glass substrates to achieve 1-D [1,2] or 2-D [16] planar motions. By altering surface tension with electrical means, droplet operations, such as transporting, splitting, and merging have been demonstrated [1-2]. Highly integrated microchips, such as human liquid diagnostics [17], PCR-integrated chip [18], and high throughput Matrix Assisted Laser Desorption/Ionization Mass Spectrometry (MALDI-MS) chip [19], have been reported. However, in digital microfluidics, device or technique to connect from chip to chip has not been reported yet.

Here, a droplet connecting interface is proposed for chip-to-chip interconnection in droplet-based microfluidic platform. By utilizing EWOD technology, it has the advantages of dead volume free, simple configuration without leakage issues and external pump. The compliant conductive polymer film (ITO PET) is proposed here to act as the substrate of interconnecting chips; therefore, even the microfluidic chips at different planes can be assembled.

2. Module design

Three microfluidic modules, including flexible module and two types of connector modules, are designed and described in the following sections.

2.1 Flexible module

The flexible module is fabricated on ITO PET substrate, which is a PET films pre-deposited with ITO film and widely used in touch panels [20]. The module is designed as a sandwiched configuration with three layers, control substrate, flexible spacer, and ground cover, as sketched in Fig. 1(a). Control substrate is a transparent PET film which has a series of control electrodes, and the ground cover has entire ITO film as the ground electrode. The flexible spacer is a frame-like layer with two parallel polymer strips and two clip rings at its two ends. Three layers are clipped together here to form structure with open ends for droplet entrance or exit. By proper clipping force, these three layers could laterally slip to release the stress during bending without losing contact. As for the interface electrodes at two ends, they are designed for electrical transmission from module to module. Figure 1(b) is the cross-sectional view of the configuration of flexible module. All control electrodes are covered with insulator and hydrophobic coating on control substrate. The detailed fabrication processes will be described in the fabrication section.

In order to minimize number of contact pads, a multiphase bus of control electrodes is used in the flexible module. [17] With three-phase bus design as shown in Fig. 2, only three contact pads are required for unlimited control electrodes to actuate droplet with two-way movement.

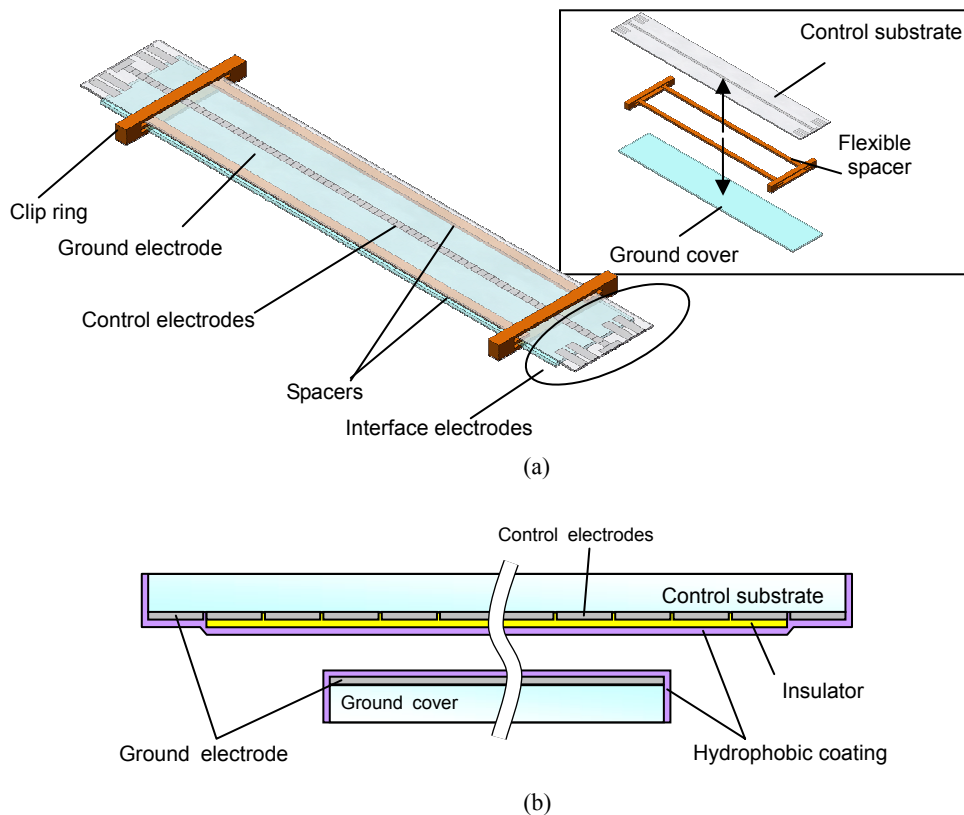

Fig. 1. Sandwiched design of flexible module. (a) Configuration in bird view. The inset is explosive view of three individual layers. (b) Cross-sectional view of the configuration of control substrate and ground cover in flexible module.

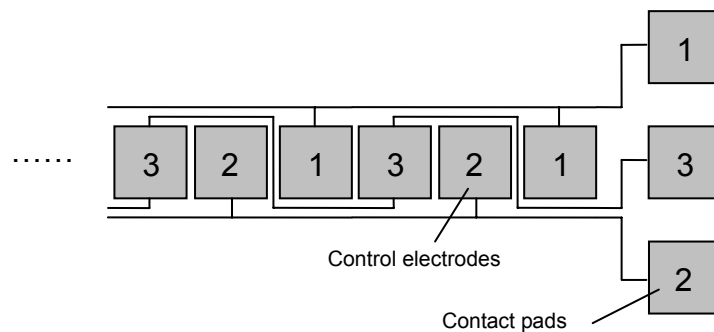

Fig. 2. Electrical layout of three-phase bus design for unlimited control electrodes to actuate droplet with two-way movement.

2.2 Connector module

Connector module is a component that connects flexible modules for mechanical assembly, electrical transmission and droplet transportation. Two types of connector module are designed, base and I/O modules. The base module is used

for connecting flexible modules. The I/O module not only has the same function as the base module, but also provides power input and signal output.

The concept of socket and plug-and-play is adopted in the connector module here. In 2003, Yang and Maeda demonstrated a socket for microchip to interconnect micro- and macro-world in continuous flow systems [21], in which both electrical and fluidic connections were established by the socket. For the concept of plug-and-play, in 2002, Igata *et al.* proposed a reversible bonding technique to realize the concept [22]. Here, by combination of both concepts, a reusable, socket-type and plug-and-play connector for digital microfluidics is developed.

Figure 3 illustrates the details of base module, where the inset indicates detached layers in the module. To be compatible with the flexible module, shorter control substrate and ground cover are designed upside down to be a complementary socket for connecting flexible module. For the spacer between control substrate and ground cover, two strips of double side print circuit board (PCB) are adopted, because the electricity need to be transmitted from the substrate to the cover via interface electrodes on both sides of PCB strips. Insertion guides are laid along the outer edge of spacers on PCB strips to form the socket for leading the interface electrodes of flexible modules to contact with interface electrode of connector module through the spacer properly. The detailed design of interface electrodes will be discussed in the following paragraph. Figure 4 shows the cross-sectional view of control substrate and ground cover in base module.

For I/O module, it has the similar configuration as base module, as shown in Fig. 5, except the additional contact pads are designed on the control substrate to provide I/O capability for power and signal connections.

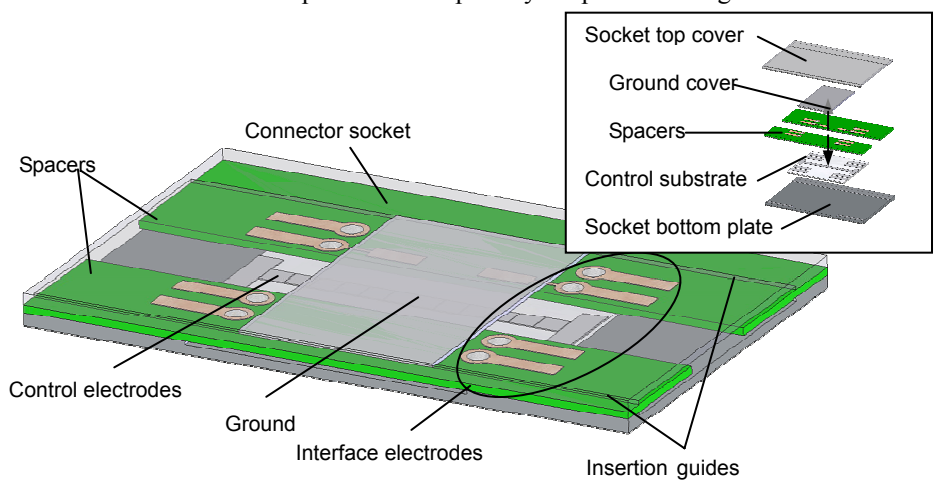

Fig. 3 The base module with the explosive view at the interface

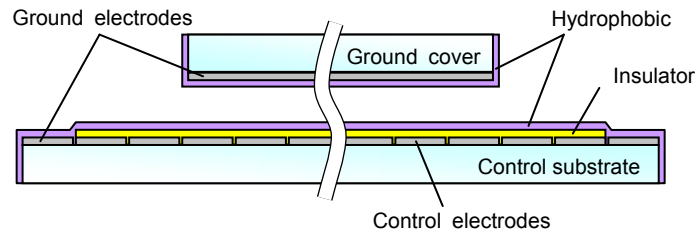

Fig. 4 Cross-sectional view of the configuration of ground cover and control substrate in base module.

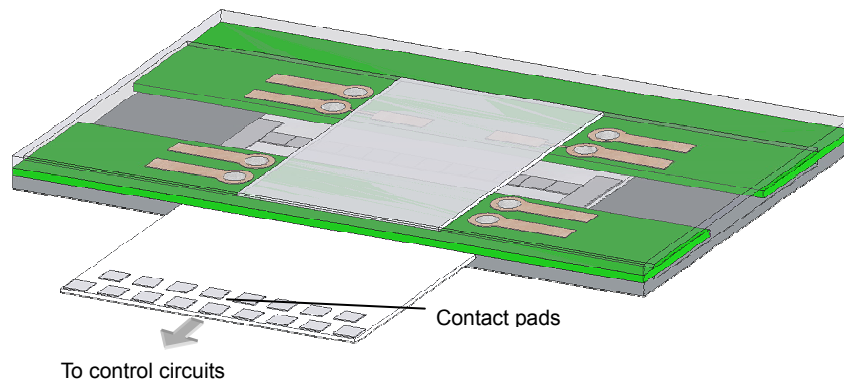

Fig. 5 The I/O module

3.3 Interface between flexible and connector modules

At the interface between flexible and connector module, two kinds of interface electrodes are designed for electrical transmission and droplet transportation respectively. As mentioned in previous section, interface electrodes are placed at both ends of flexible and connector module for the connections. Figure 6 shows the interface while flexible module plugging into connector module. The electric interface electrodes on both control substrates can transmit electrical signal from connector module through the spacer (PCB strips) to the flexible module. Due to three-phase bus design, total four electrodes are enough in all modules, where three of them are designed for the signal of control electrode and one is for the ground electrode.

For the droplet transportation, the fluid interface electrodes on both modules will be overlapped, as shown in Fig. 6. At overlapping region, two interface gaps are produced at the bottom-left and upper-right corners of the region, as shown in the cross-sectional view of Fig. 6. During droplet transportation from connector to flexible module, the droplet first moves across upper-right gap to the overlapping region, then crosses the bottom-left gap to reach the flexible module. In this design, the capability for droplet to cross two interface gaps by EWOD actuations is very critical, and the experimental investigation will be discussed in the testing section.

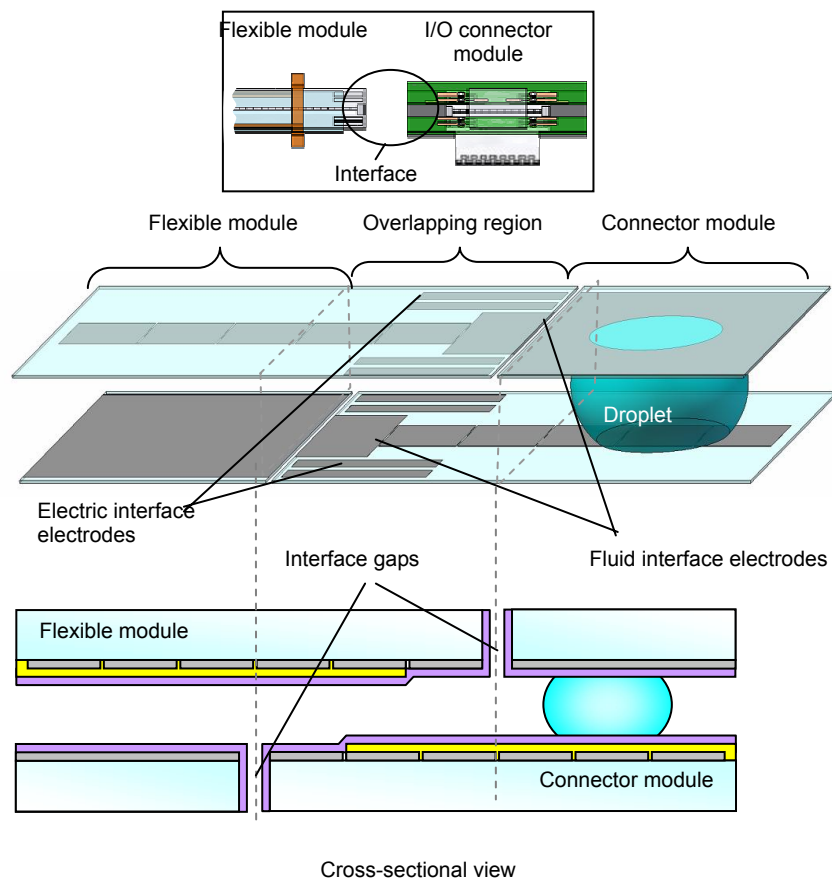

Fig. 6. Illustration on the interface between flexible and connector modules.

4. Fabrication

Here, ITO PET film is used as the substrate material for flexible and two connector modules, although two connector modules are not necessary to be fabricated on flexible films. However, in order to avoid thickness mismatch between flexible and connector modules at the interface, all modules are made on ITO PET films.

Because melting point of PET is around 250 °C, fabrication process should be performed far below the melting point, and chemicals used in processes should not react with the ITO PET films. Therefore, instead of using high temperature LPCVD or PECVD to deposit dielectric materials, negative photoresist, SU-8, is used as insulator for its high transparency and low process temperature.

The ITO on the flexible substrates is patterned by wet etching at room temperature. Then, the 1 μ m-thick SU-8 is coated and patterned on control electrodes as the insulator. Finally, 66 nm-thick Teflon is spun on as hydrophobic coating, and dried in the ambience. For the ground cover, only a 66 nm-thick Teflon layer is deposited without insulator layer. At last, conductive copper-foil tapes are placed on each electric interface electrodes to enhance the conductivity

between ITO electrodes and copper electrodes on the PCB strips. The substrate edges at interface gap are then vertically cut to generate a smooth and flat surface, and coated with Teflon again to prevent droplet sticking at the edge.

5. Testing

5.1 Droplet transportation on bended flexible module

The droplet transportation on curved surface is first examined by testing on four different curvatures from 0 to 0.06 mm^{-1} . For zero curvature, the flexible module is placed vertically without bending. It should be noted that, by clipping to the curved fixture, the 90° point is the position for droplet needing to overcome the largest gravity force when passing through from the bottom to the top, as shown in Fig. 7(a). Figure 7(b) is the experimental results of minimum required voltage for droplet around $2.5 \mu\text{l}$ overcoming the 90° position at different curvatures. It is shown that droplet can be successfully transported along the curved surface in the flexible module by electrowetting actuations. The gravity shows only little influence, where the required voltage remains around $70 V_{AC}$ at the different curvatures from 0 to 0.06 mm^{-1} .

5.2 Interface test between flexible and connector module

The droplet has to pass through two interface gaps between two modules in our design; therefore, the feasible gap size needs to be identified. The testing configuration is plotted in Fig. 8(a), where two covers with ground electrodes and control electrodes are used to form the interface gap which is aligned to the middle of two control electrodes on the substrate. The width of control electrodes is $1500 \mu\text{m}$, and thickness of spacer is $500 \mu\text{m}$. Images for two kinds of behaviors of droplet to cross the $200 \mu\text{m}$ gap are shown in Fig. 9(b). With the insufficient actuation voltage, the right contact angle of droplet is decreased obviously; but instead of moving, droplet stands still at original position. On the other hands, when sufficient voltage is applied ($100 V_{AC}$), the droplet can jump over the gap, and then moves to the next electrode. All the successful cases for droplet with three different volumes, $1.5 \mu\text{l}$, $2.5 \mu\text{l}$, and $3.5 \mu\text{l}$, to pass through various gap sizes from $0 \mu\text{m}$ to $350 \mu\text{m}$ are shown in Fig. 9(c), where $0 \mu\text{m}$ cover gap means testing on a single cover. Higher voltages are needed for bigger droplet or larger gap in general. For example, the required voltage needs to be raised over $120 V_{AC}$ for $1.5 \mu\text{l}$ and $2.5 \mu\text{l}$ droplets at $350 \mu\text{m}$ gap, where droplet of $3.5 \mu\text{l}$ can not cross the $350 \mu\text{m}$ gap even at $140 V_{AC}$. It is also found that for $50 \mu\text{m}$ gap, the actuation voltage of $80 V_{AC}$ is enough for all droplets to cross the gaps. In addition, over $140 V_{AC}$, the satellite droplet is generated numerously around the powered electrode due to the high voltage applied on the insulator [23].

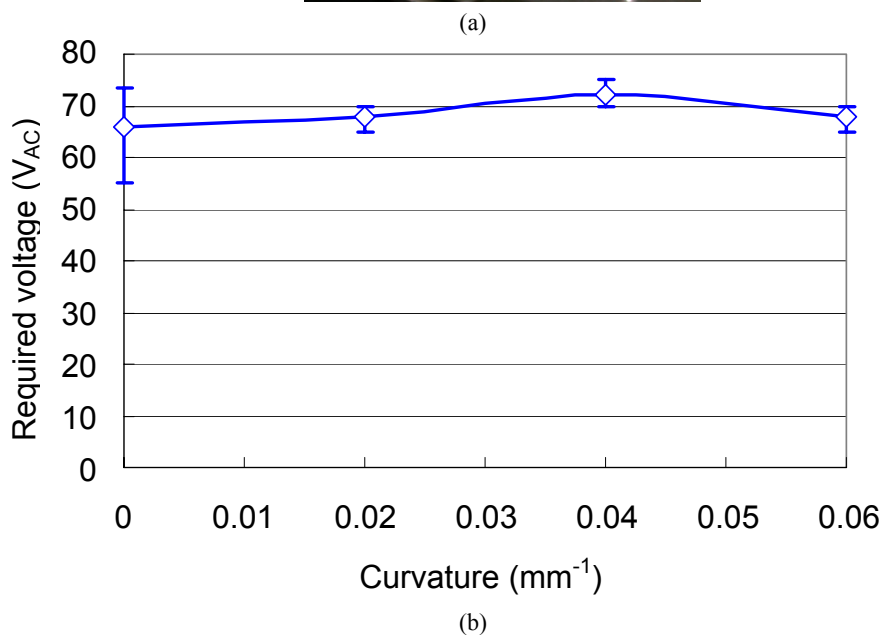
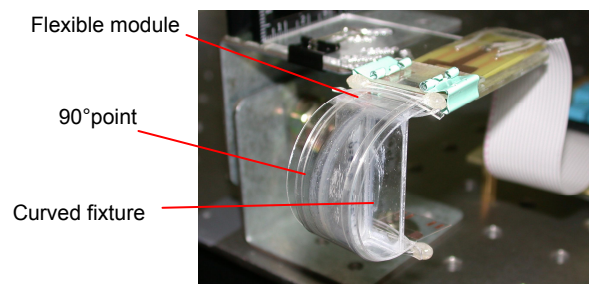

Fig. 7 Curvature investigation. (a) Experimental setup. (b) Minimum required voltage for droplet overcoming the 90° turning point. A power of 2 kHz sine wave is applied on the control electrode. The droplet is around 2.5 μl DI water, control electrode is 1500 μm wide, and spacer is 500 μm thick.

Next, flexible and connector modules are assembled to verify the capability for droplet transportation at the interface between two modules. Figure 9(a) shows the signal sequences for control electrodes during droplet movement. Two electrical states, powered and grounded are applied on the control electrodes according to the sequences, and the ground electrodes are always grounded. Electrode 1, 2, and 3 are the control electrodes of flexible module and electrode 4, 5, and 6 are in the connector module. Electrode 3 and 4 are overlapped, but on different substrates. Figure 9(b) is the continuous images on movements of a 2.5 μl droplet, where the control electrodes are 1500x1500 μm , the interface gaps are adjusted to be around 50 μm , and the applied voltage is 2k Hz sine wave with 80 V_{AC} . It is shown that the droplet follows well with the powered electrode according to the control sequences. This result confirms the transporting capability of droplet-based interface between flexible and connector module. It should be pointed out that the sidewall profile on the gap is critical to the performance. Figure 10 shows two different sidewall profiles. With proper cutting technique, a smooth perpendicular sidewall is achieved for successful droplet transportation between modules.

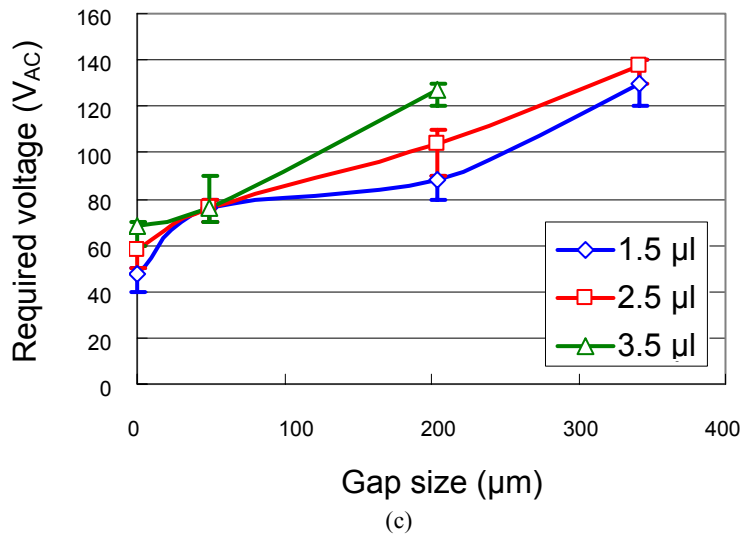
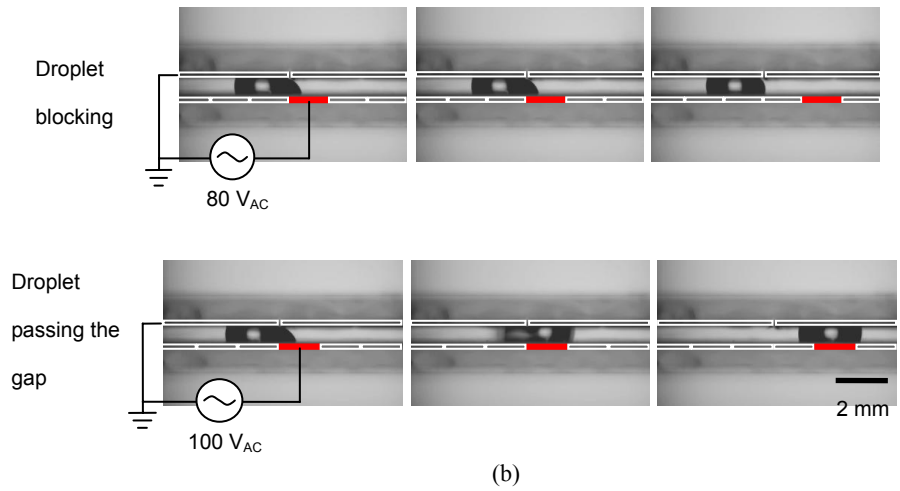
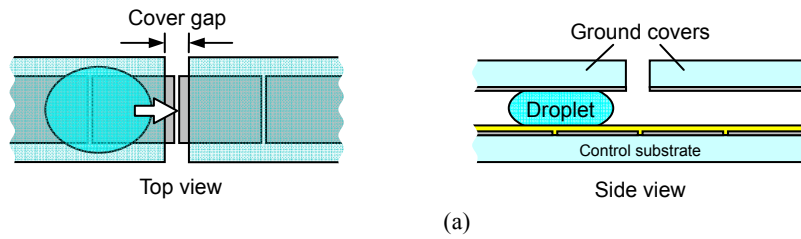

Fig. 8 Gap size investigation. (a) Experimental setup. (b) Blocking and successful passing the gap. Electrode width is 1500 μm and spacer thickness is 500 μm . The gap size is 200 μm for droplet volume of 2.5 μl . (c) Minimum required voltage for droplet successfully passing through the gap.

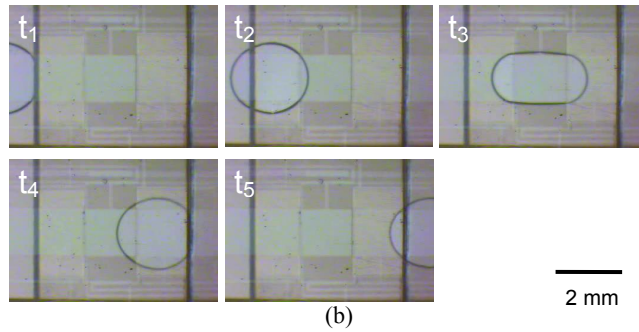
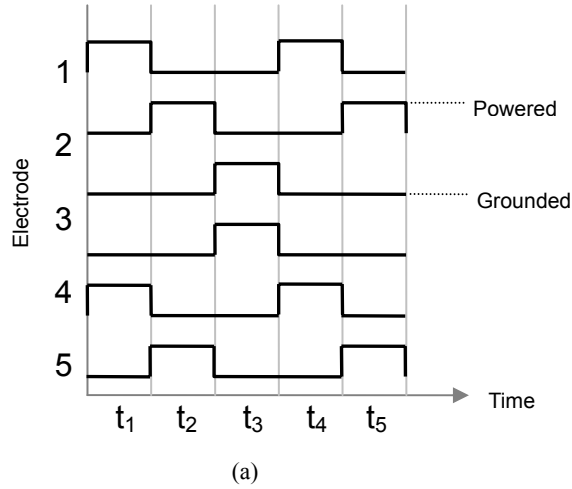
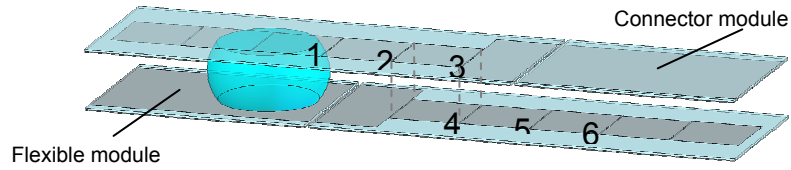

Fig. 9 Interface tests. (a) Electrical states for control electrodes at each period. (b) Continuous images for droplet passing through the connector. The electrode is 1500 μm wide, the droplet is 2.5 μl DI water, and the applied voltage is 80 V_{AC} , 2 kHz sine wave.

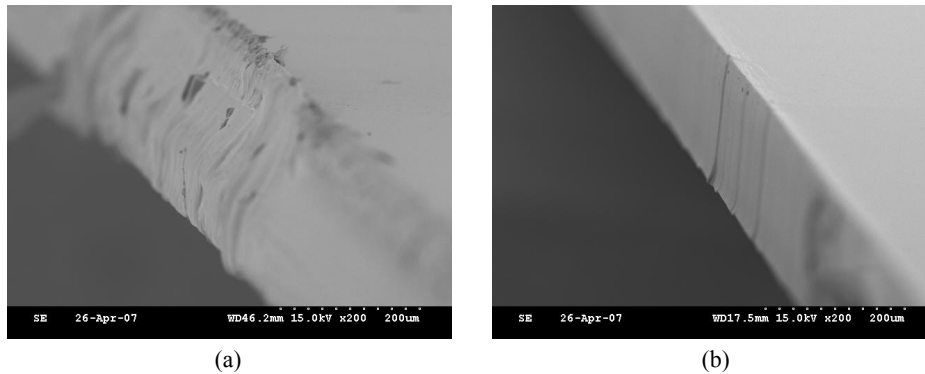

Fig. 10 Two different profiles at the side wall of interface gap: (a) Rough surface. (b) Smooth perpendicular sidewall

6. Conclusion

Three kinds of modules with connecting interface are designed and fabricated on the flexible substrate here to transport droplets between microfluidic chips even at different planes. By using more compliant substrate, it is possible to further reduce the curvature of the flexible module. Furthermore, by modifying the electrode layout, the technique proposed here shows a promising approach leading to a multi-layer microfluidic chip, or the lab-on-a-chip with capability of 3D droplet transportation.

Acknowledgements

Authors would like to thank the Nano Facility Center at National Chiao Tung University, Hsinchu, Taiwan for providing fabrication facilities, and the Join Well Co., Ltd for supporting the ITO PET films and related technical services. This work is partially supported by the National Science Council, Taiwan, under grant NSC 95-2218-E-009-023.

Reference

- [1] S. C. Jakeway, A. J. de Mello, and E. L. Russell, *Fresenius J. Anal. Chem.*, **366**, 525-539(2000).
- [2] D. R. Reyes, D. Iossifidis, P. -A. Auroux, and A. Manz, *Anal. Chem.*, **74**, 2623-2636(2002).
- [3] D. Erickson, and D. Li, *Anal. Chim. Acta*, **507**, 11-26(2004).
- [4] M. U. Kopp, A. J. de Mello, and A. Manz, *Science*, **280**, 1046-1048(1998).
- [5] N. -T. Nguyen, and Z. Wu, *J. Micromech. Microeng.*, **15**, R1-R16,(2005).
- [6] R. H. Liu, J. Yang, R. Lenigk, J. Bonanno, and P. Grodzinski, *Anal. Chem.*, **76**, 1824-1831(2004).
- [7] C. K. Fredrickson and Z. H. Fan, *Lab Chip*, **4**, 526-533(2004).
- [8] M. A. Burns, B. N. Johnson, S. N. Brahmasandra, K. Handique, J. R. Webster, M. Krishnan, T. S. Sammarco, P. M. Man, D. Jones, D. Heldsinger, C. H. Mastrangelo and D. T. Burke, *Science*, **282**, 484-487(1998).
- [9] E. T. Lagally, C. A. Emrich and R. A. Mathies, *Lab Chip*, **1**, 102-107(2001).
- [10] G. H. Seong, J. Heo and R. M. Crooks, *Anal. Chem.*, **75**, 3161-3167(2003).
- [11] B. L. Gray, D. Jaeggi, N. J. Mourlas, B. P. van Driehuisen, K. R. Williams, N. I. Maluf and G. T. A. Kovacs, *Sens. Actuators A*, **77**, 57-65(1999).
- [12] N. H. Bings, C. Wang, C. D. Skinner, C. L. Colyer, P. Thibault and D. J. Harrison, *Anal. Chem.*, **71**, 3292-3296(1999).
- [13] H. Chen, D. Acharya, A. Gajraj and J. -C. Melners, *Anal. Chem*, **75**, 5287-5291(2003).
- [14] M.G. Pollack, R.B. Fair and A.D. Shenderov, *Appl. Phys. Lett.*, **77**, 1725-1726(2000).
- [15] S. K. Cho, H. Moon, and C.-J. Kim, *J. Microelectromech. Syst.*, **12**, 70-80(2003).
- [16] S. -K. Fan, C. Hashi, and C. -J. Kim, IEEE Conference Micro Electro Mechanical Systems (MEMS '03), Kyoto,

Japan, 2003.

- [17] V. Srinivasan, V. K. Pamula and R. B. Fair, *Lab Chip*, **4**, 310-315(2004).
- [18] Y. -H. Chang, G. -B. Lee, F. -C. Huang, Y. -Y. Chen, and J. -L. Lin, *Biomed. Microdevices*, **8**, 215-225(2006).
- [19] H. Moon, A. R. Wheeler, R. L. Garrell, J. A. Loobc and C. -J. Kim, *Lab Chip*, **6**, 1213-1219(2006).
- [20] B. G. Lewis, and D. C. Paine, *MRS Bull.*, **25**, 22-27(2000).
- [21] Z. Yang, and R. Maeda, *J. Chromatogr. A*, **1013**, 29-33(2003).
- [22] E. Igata, M. Arundell, H. Morgan, and J. M. Cooper, *Lab Chip*, **2**, 65-69(2002).
- [23] M. Vallet, B. Berge, and L Vovelle, *Polymer*, **37**, 2465-2470(1996).