

圖 3.1 各特性法之示意圖：(1) 顯式法；(2) 隱式法；(3) 空間延後法；(4) 時間延後法。



圖 3.2 可蘭數與最大延後數示意圖



圖 3.3 多方式特性法線性內差示意圖

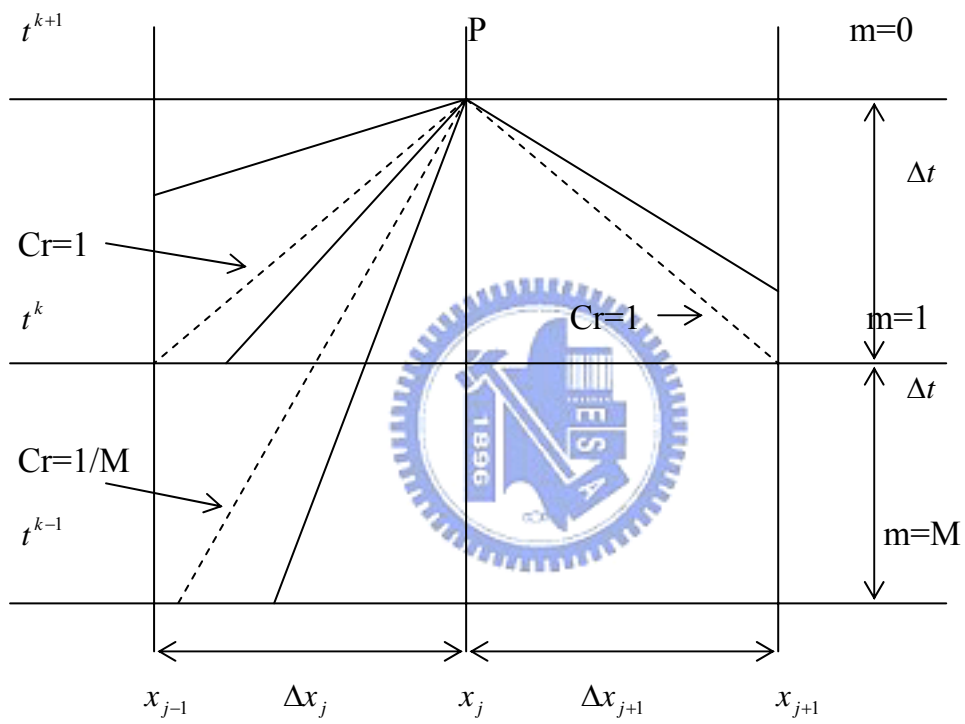

圖 3.6 多方式特性法演算流程圖

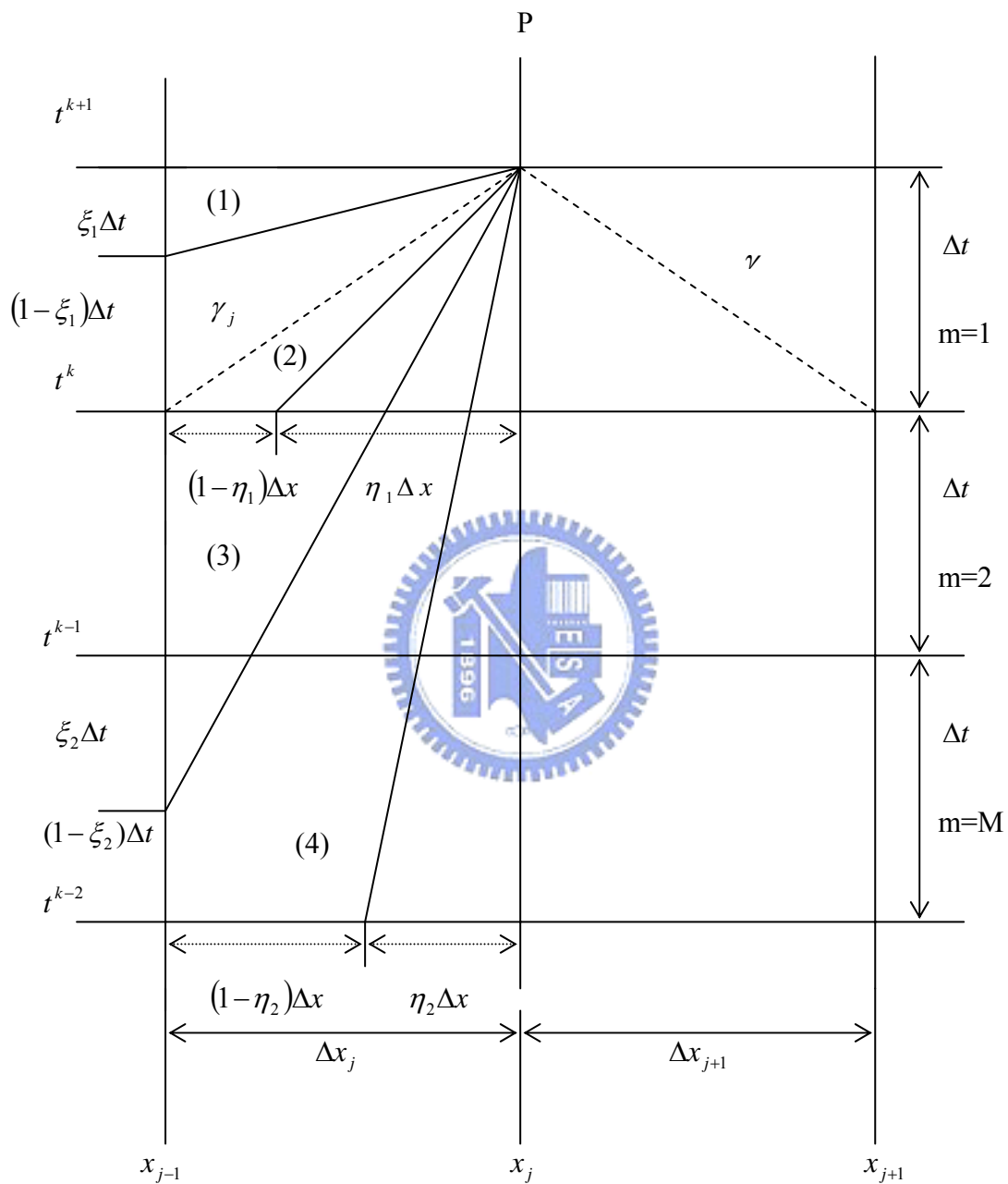

圖 4.1 單一渠道水位沿程圖

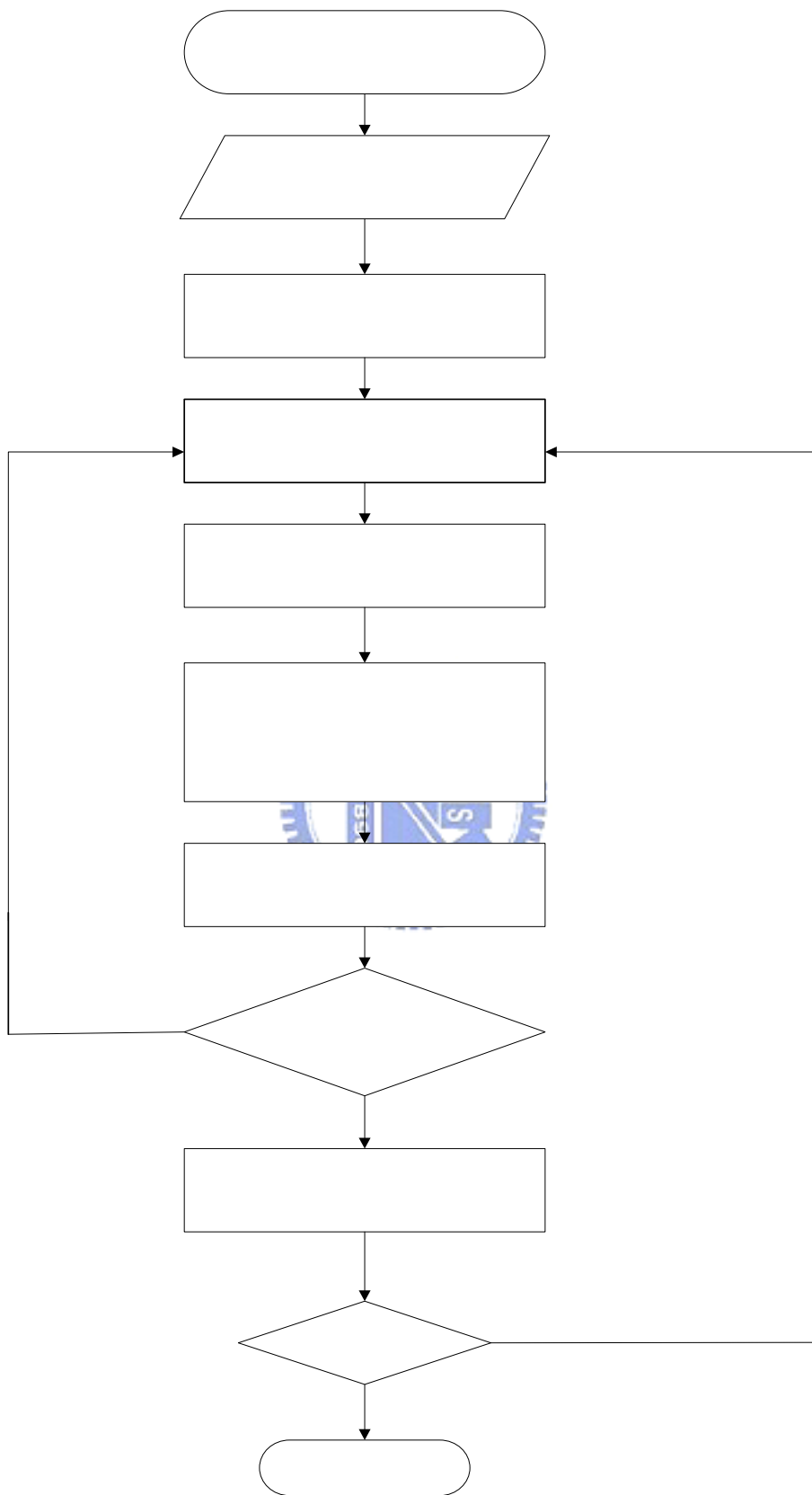

圖 4.2 單一渠道流量延時歷線圖

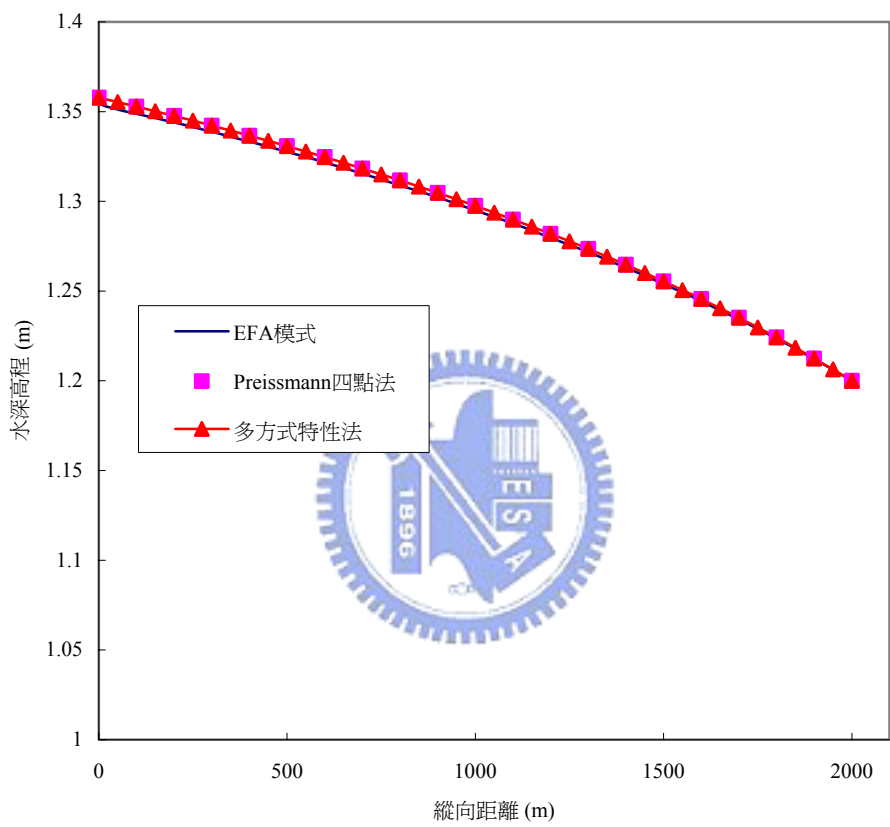

圖 4.3 單一渠道水位延時歷線圖

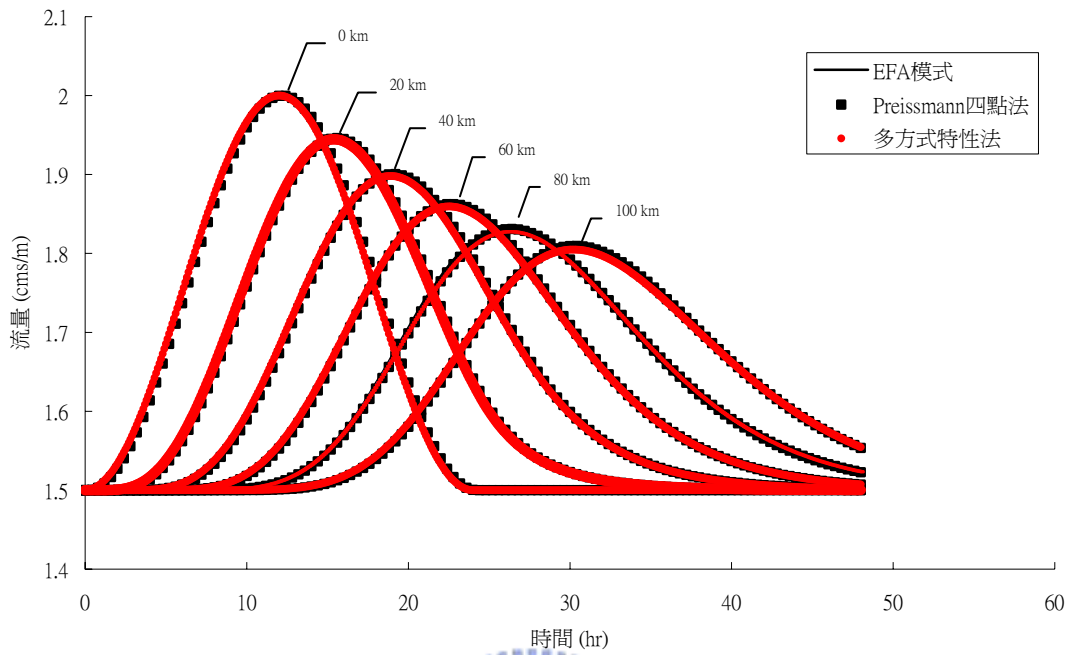

圖 4.4 交匯角度 45 度實驗渠道配置圖

(摘自張, 1995)

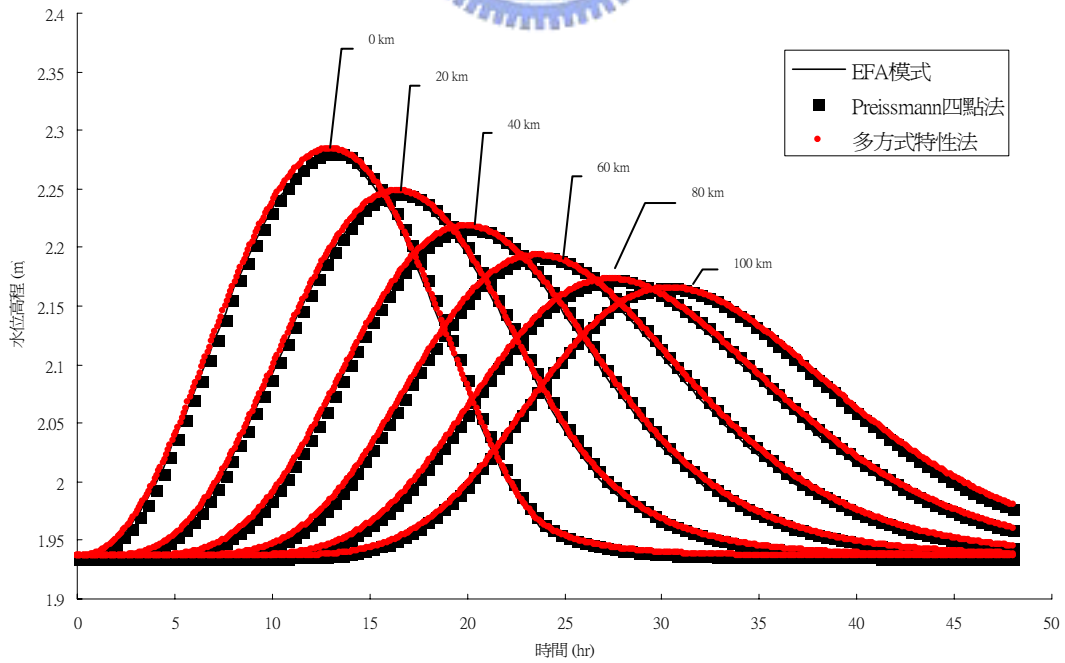



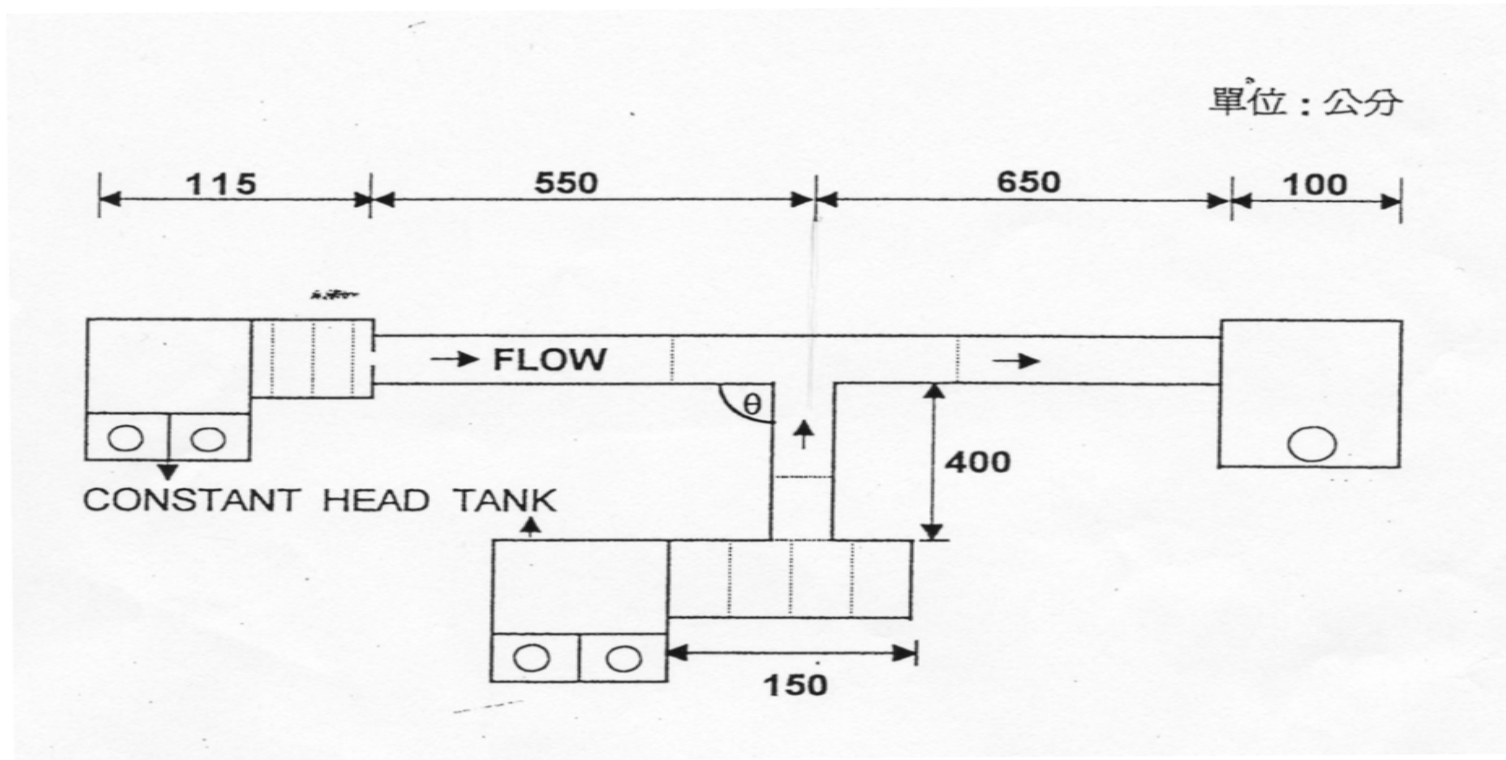

圖 4.6 交匯角度 45 度主流上游水深比較圖



圖 4.7 交匯角度 45 度支流上游水深比較圖

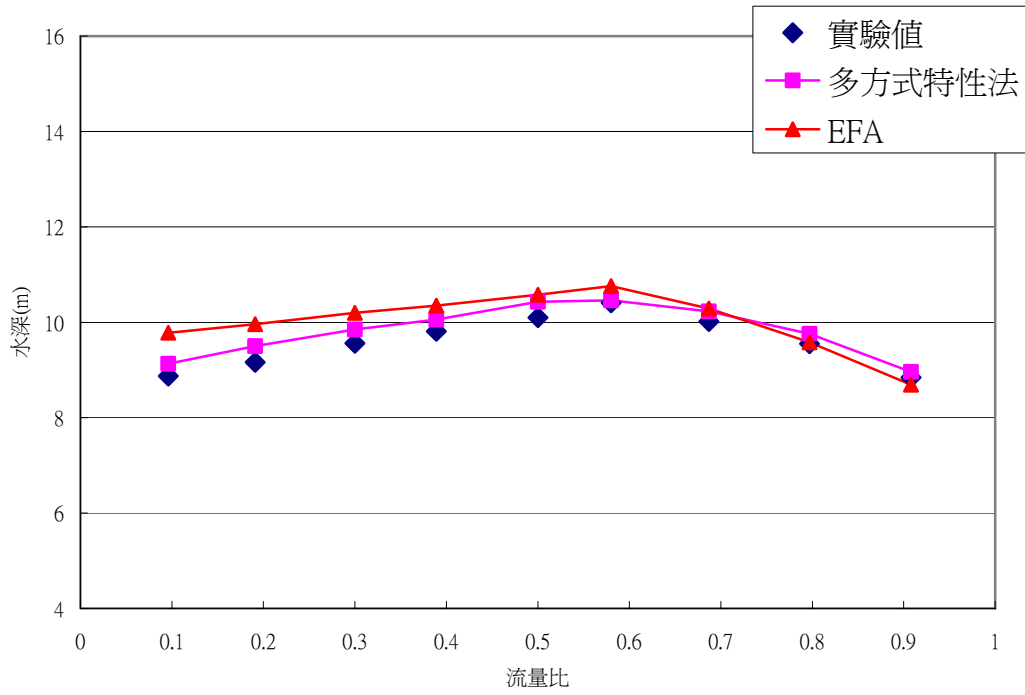

單位:公分

圖 4.8 非等寬交匯渠道配置及尺寸圖

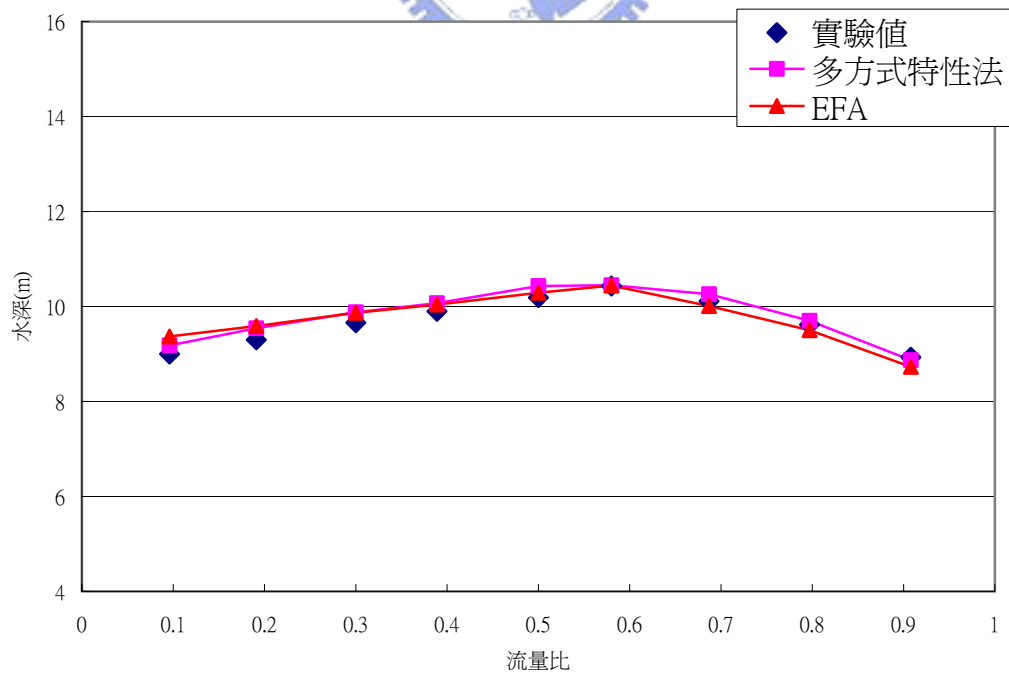
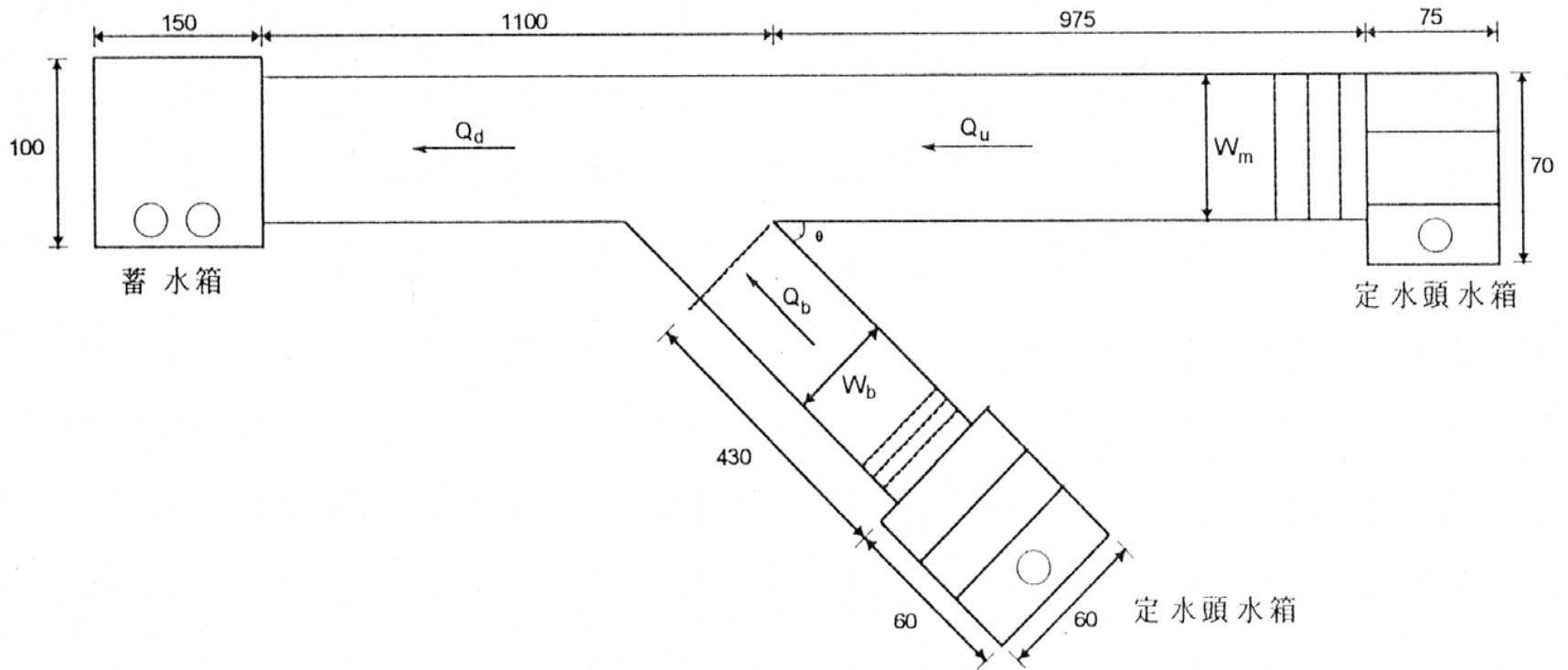
(摘自吳, 2001)



圖 4.9 非等寬交匯渠道量測斷面圖

(摘自吳，2001)

渠寬比 0.462

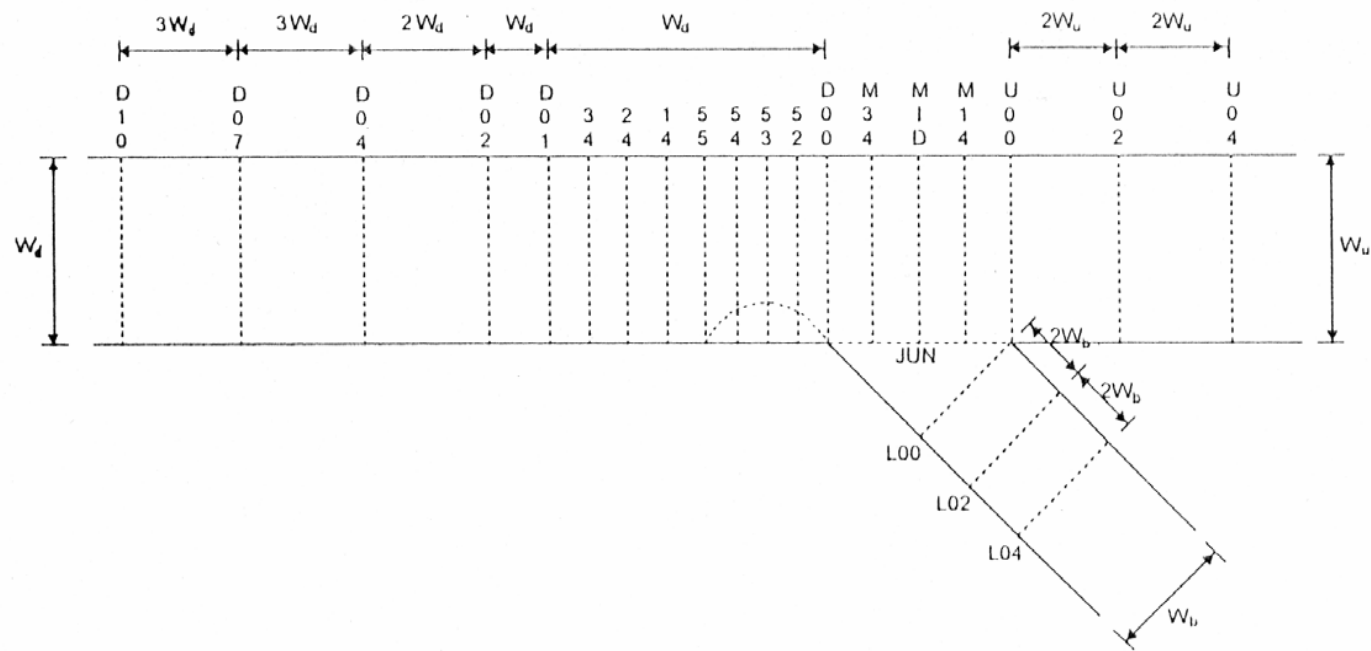

圖 4.10 交匯角度 30 度主流上游水深比較圖

渠寬比 0.462



渠寬比 0.723

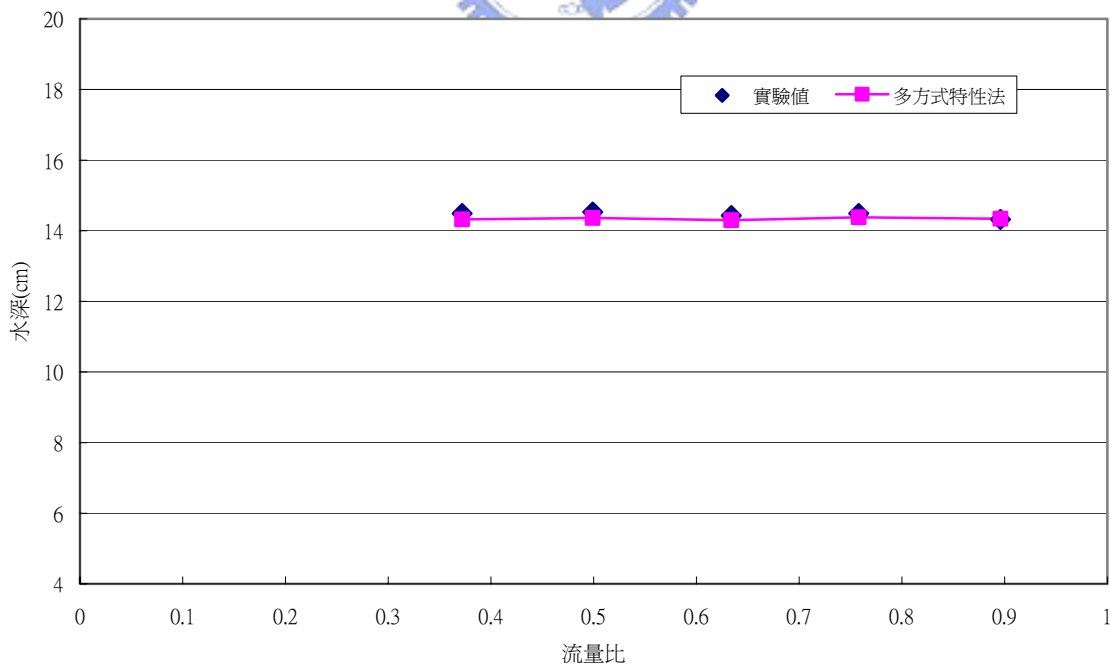
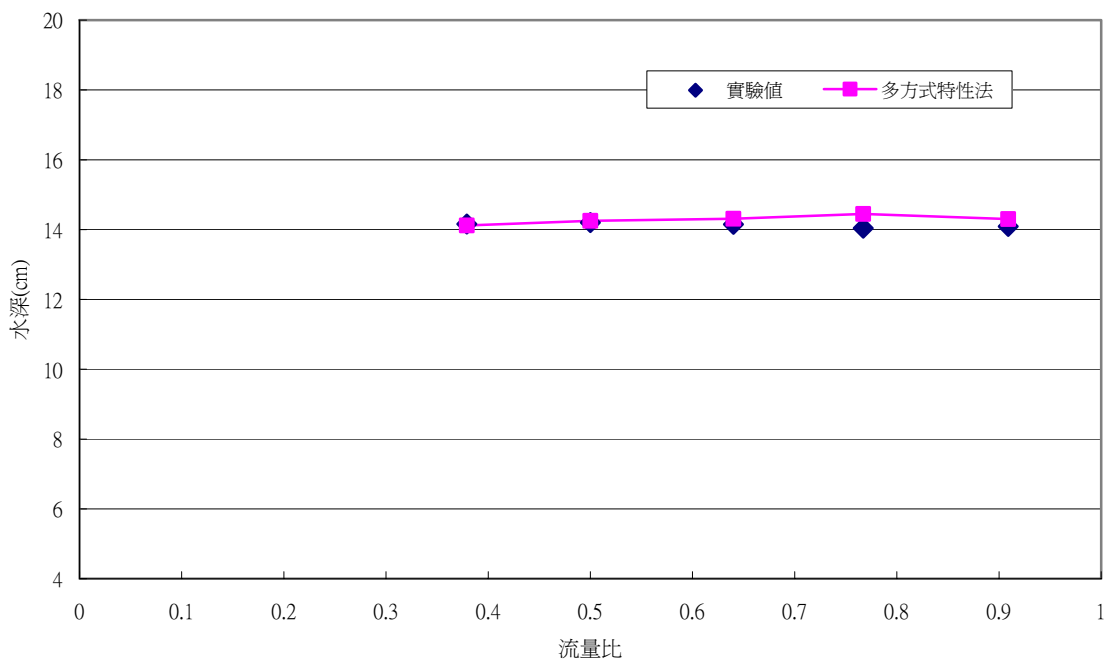
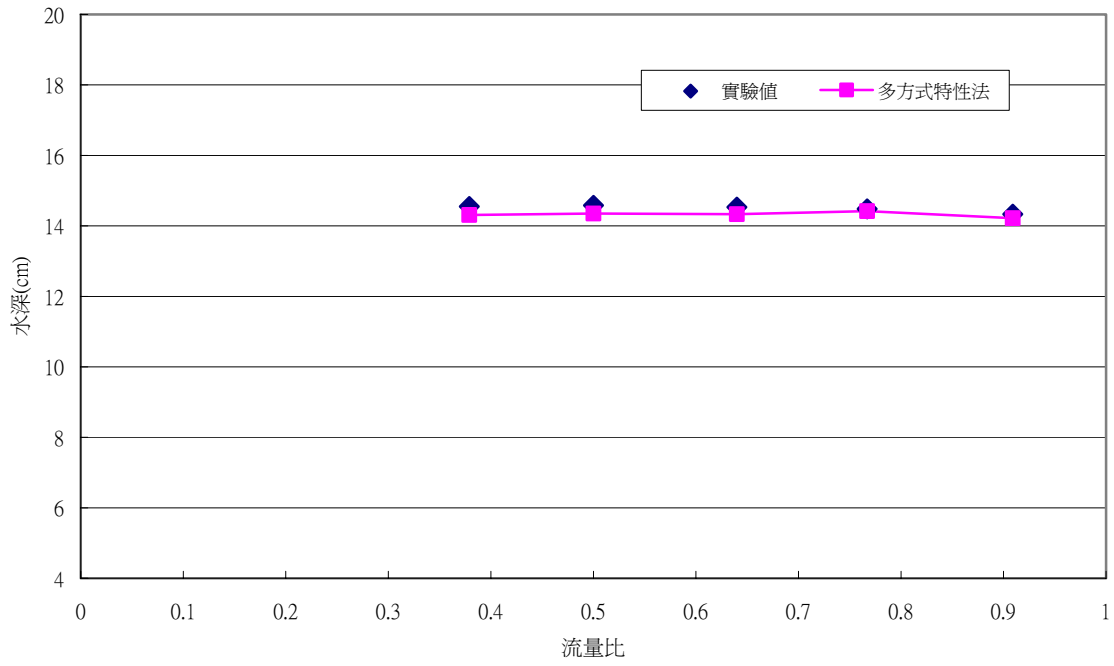

圖 4.11 交匯角度 30 度支流上游水深比較圖

渠寬比 0.462



渠寬比 0.723

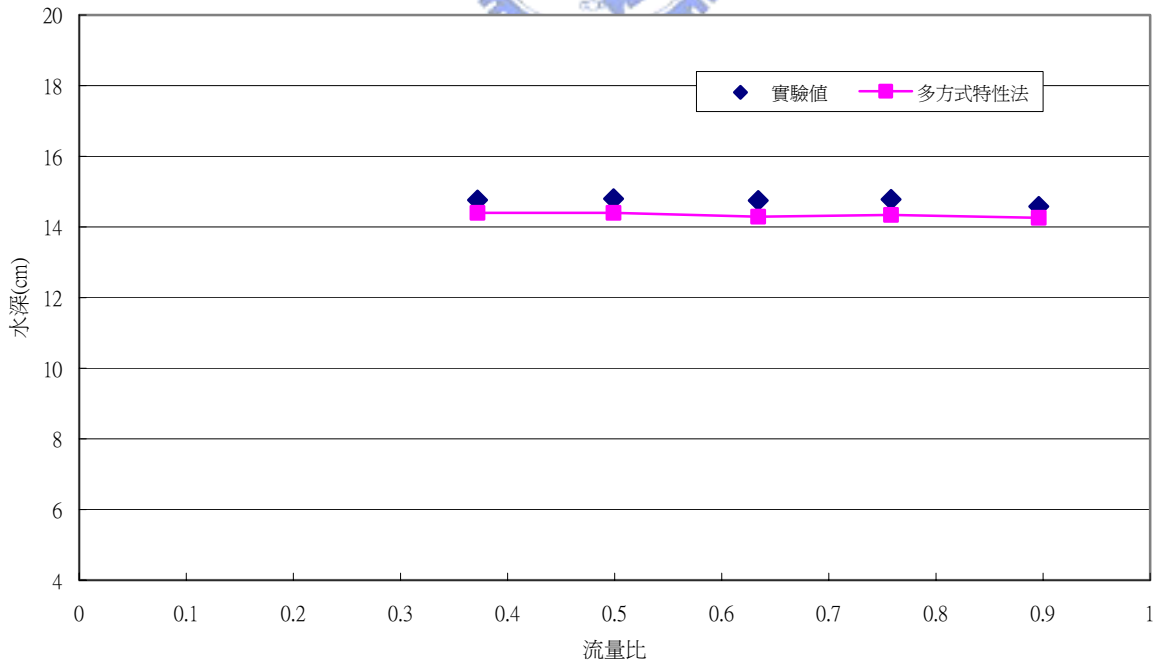
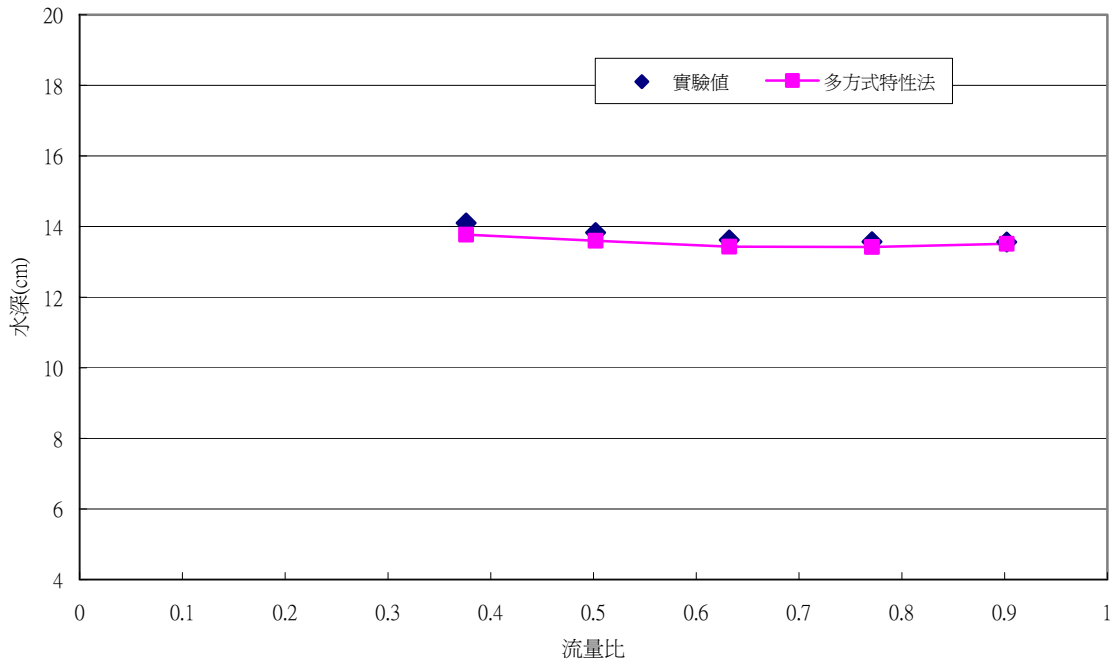

圖 4.12 交匯角度 60 度主流上游水深比較圖

渠寬比 0.462

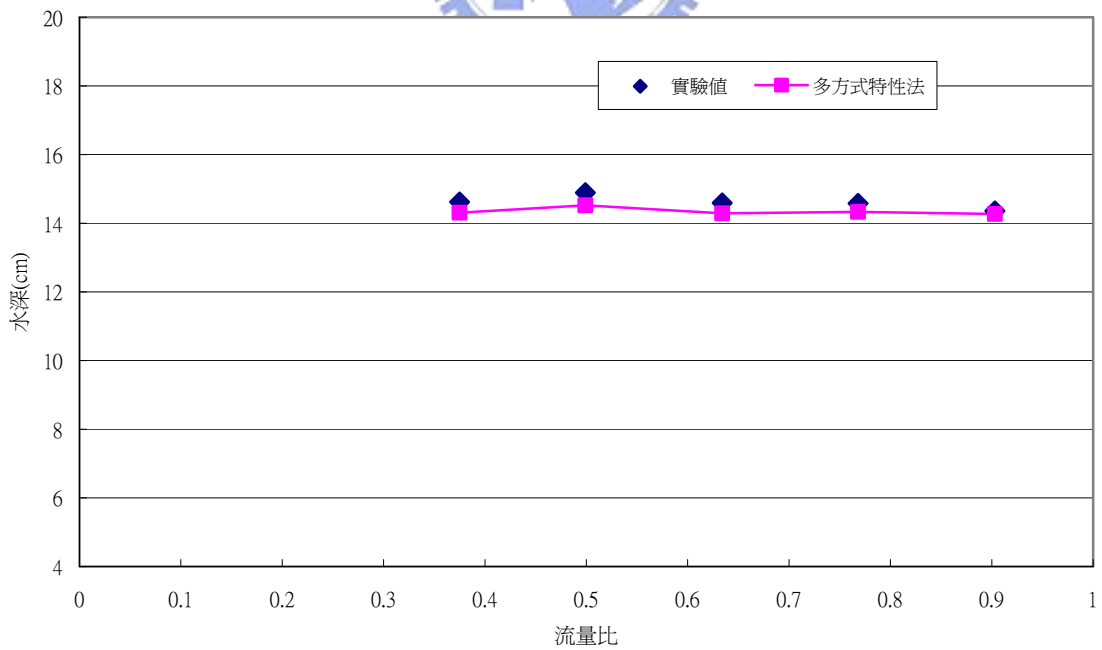

圖 4.13 交匯角度 60 度支流上游水深比較圖

渠寬比 0.462



圖 4.14 交匯角度 90 度主流上游水深比較圖

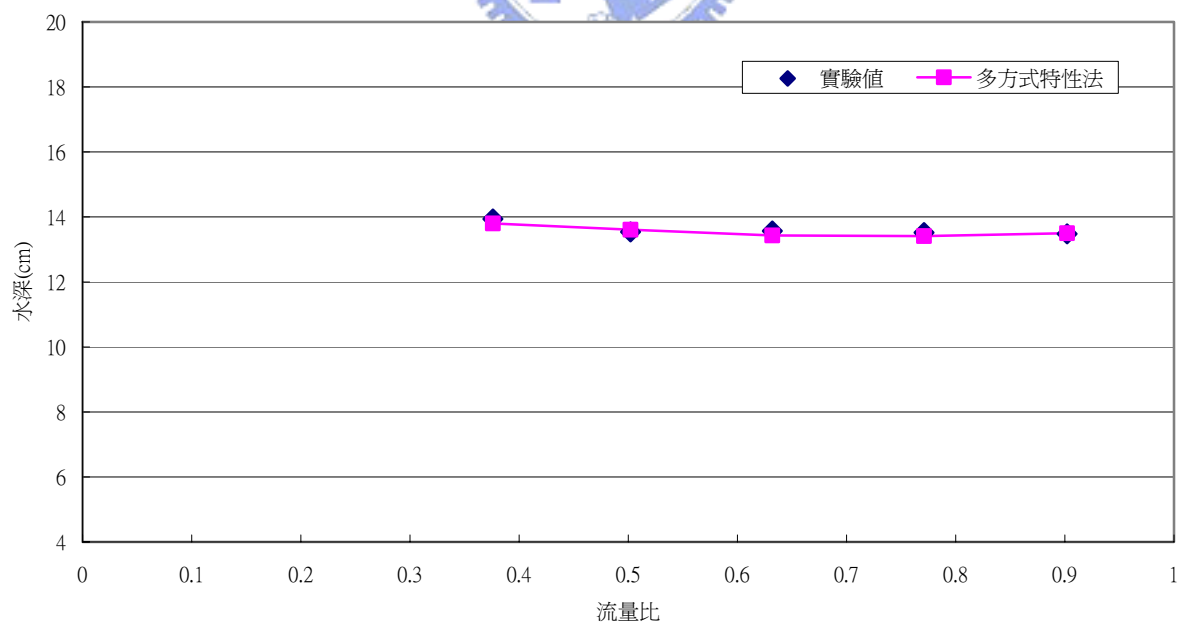
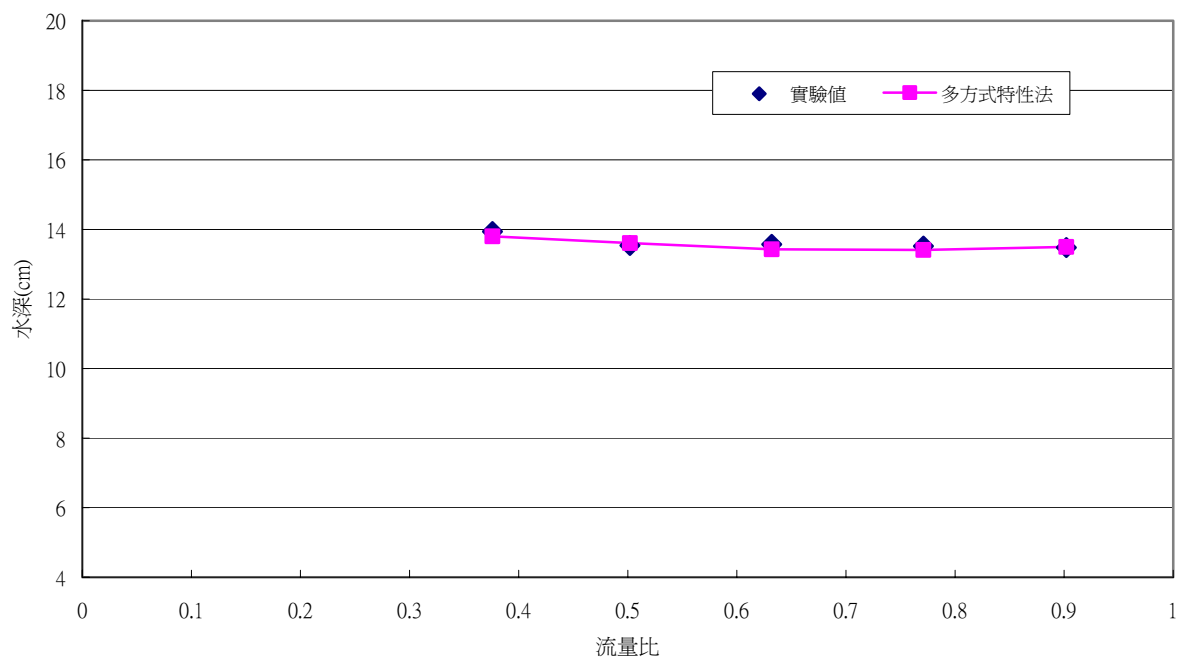

渠寬比 0.462

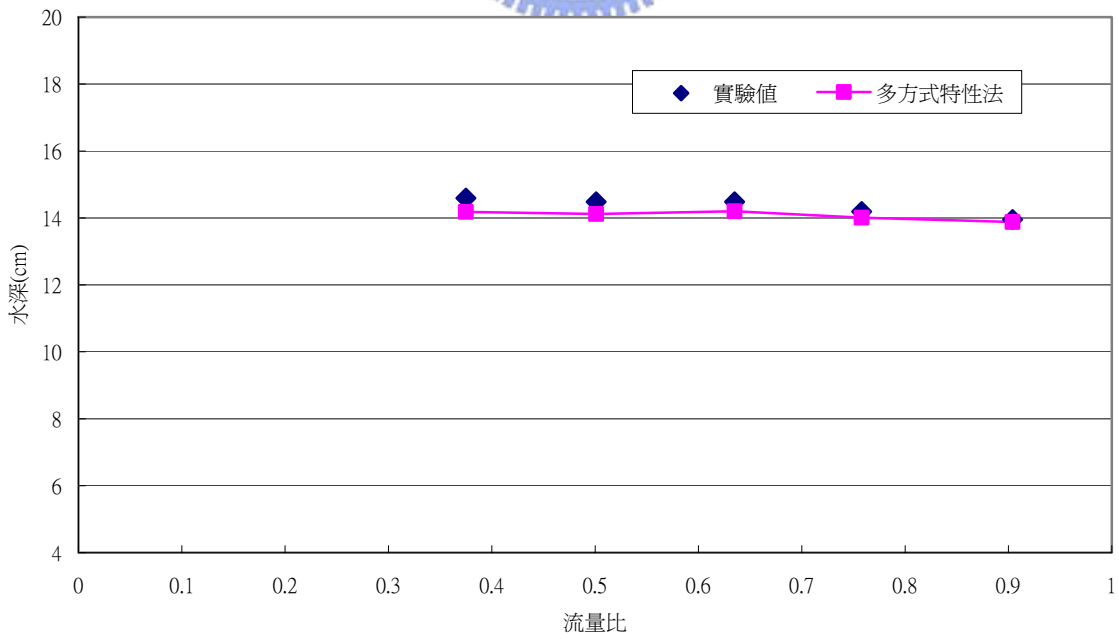
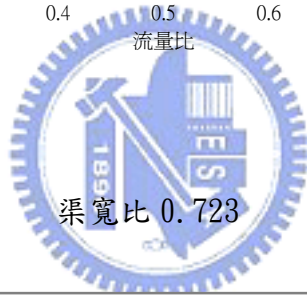
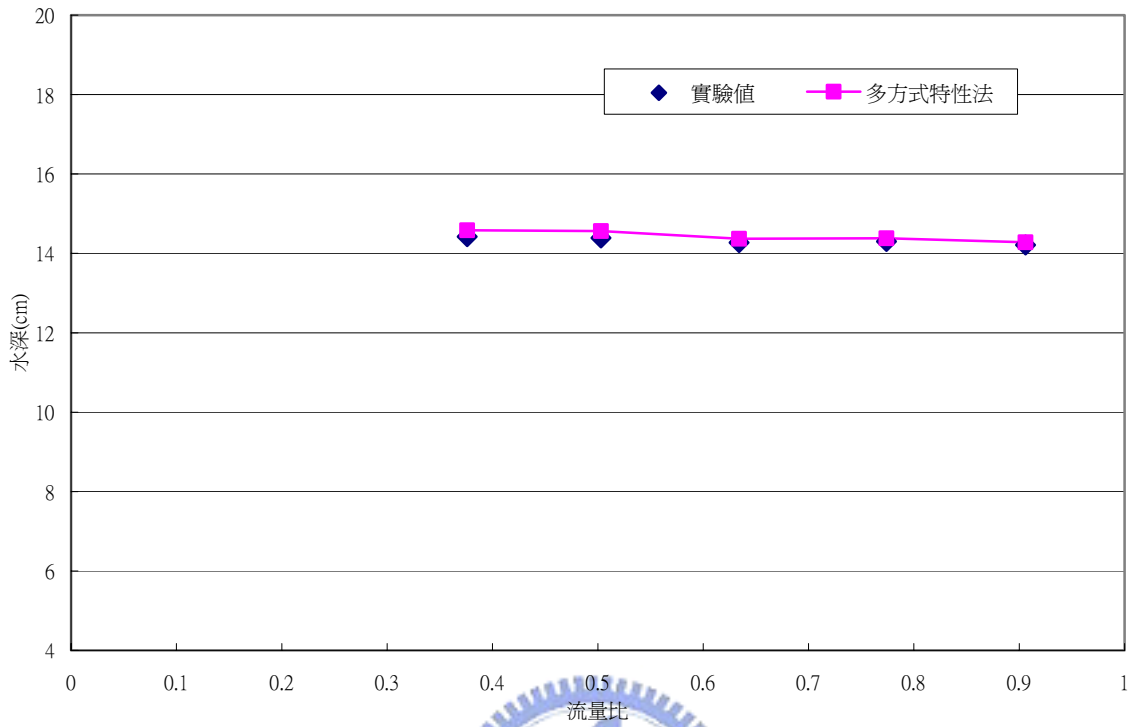
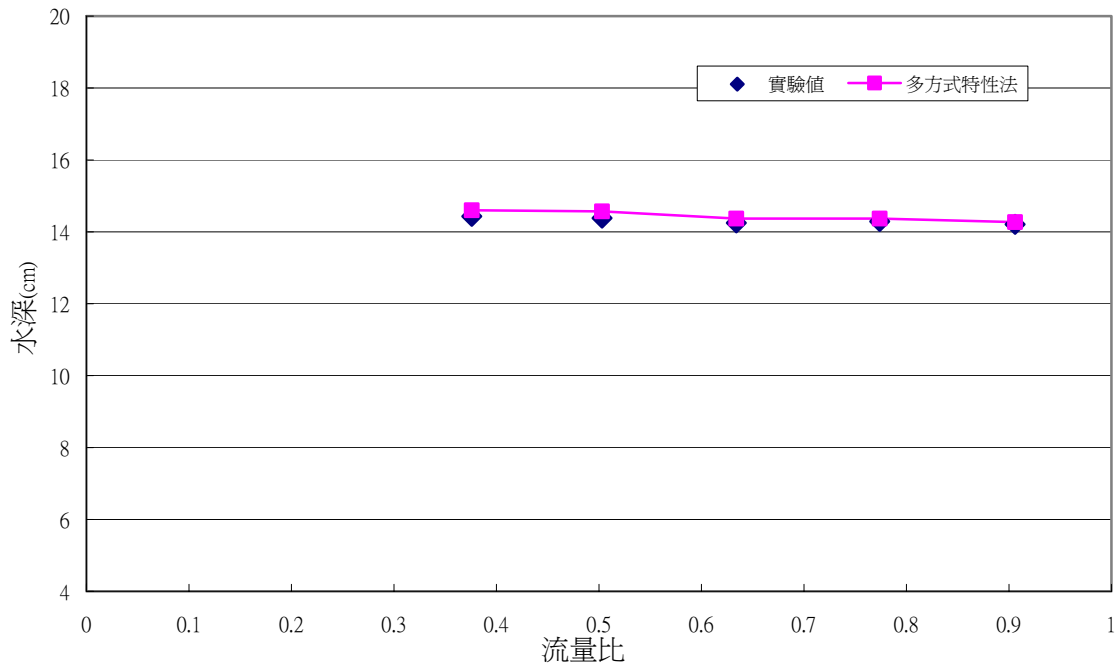

渠寬比 0.723



圖 4.15 交匯角度 90 度支流上游水深比較圖



圖 4.16 分流實驗量測斷面圖

(摘自樊, 1998)

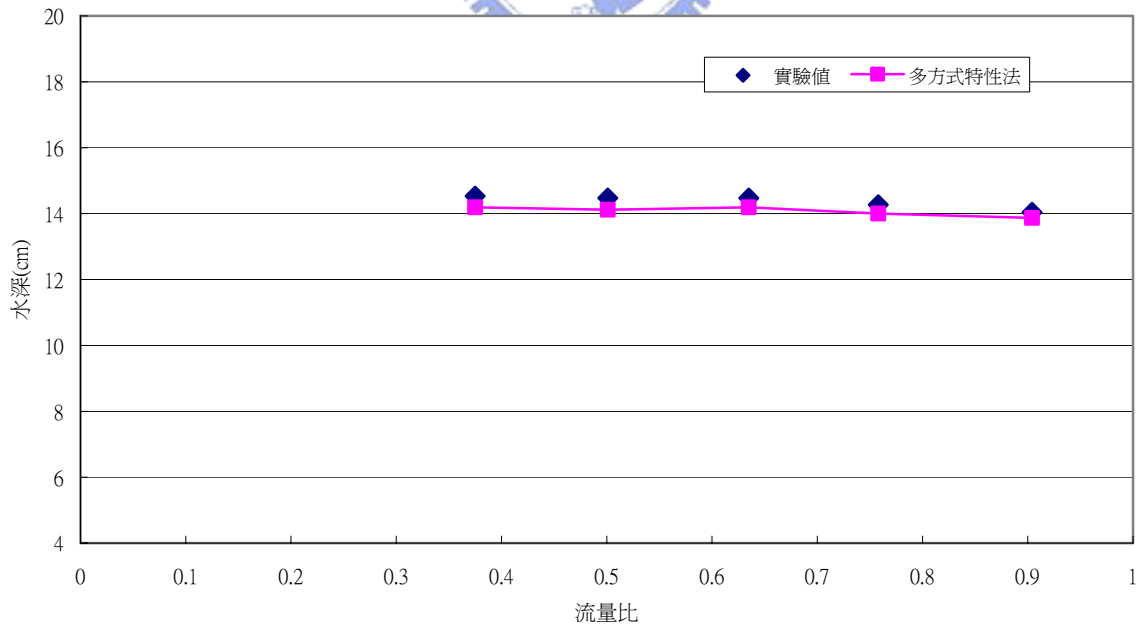

圖 4.17 分流角度 90 度主流下游流量比較圖

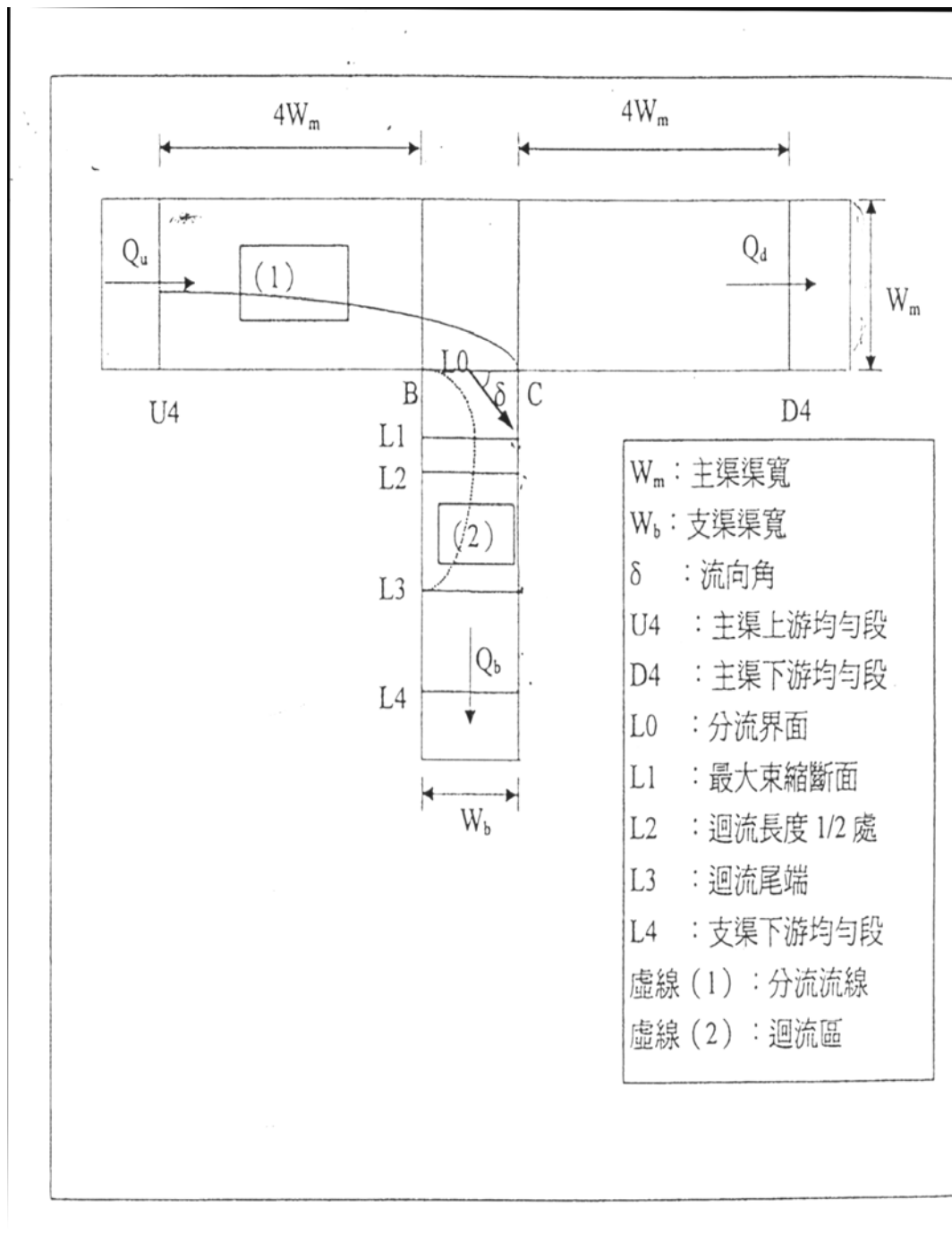

圖 4.18 分流角度 90 度主流上游水深比較圖

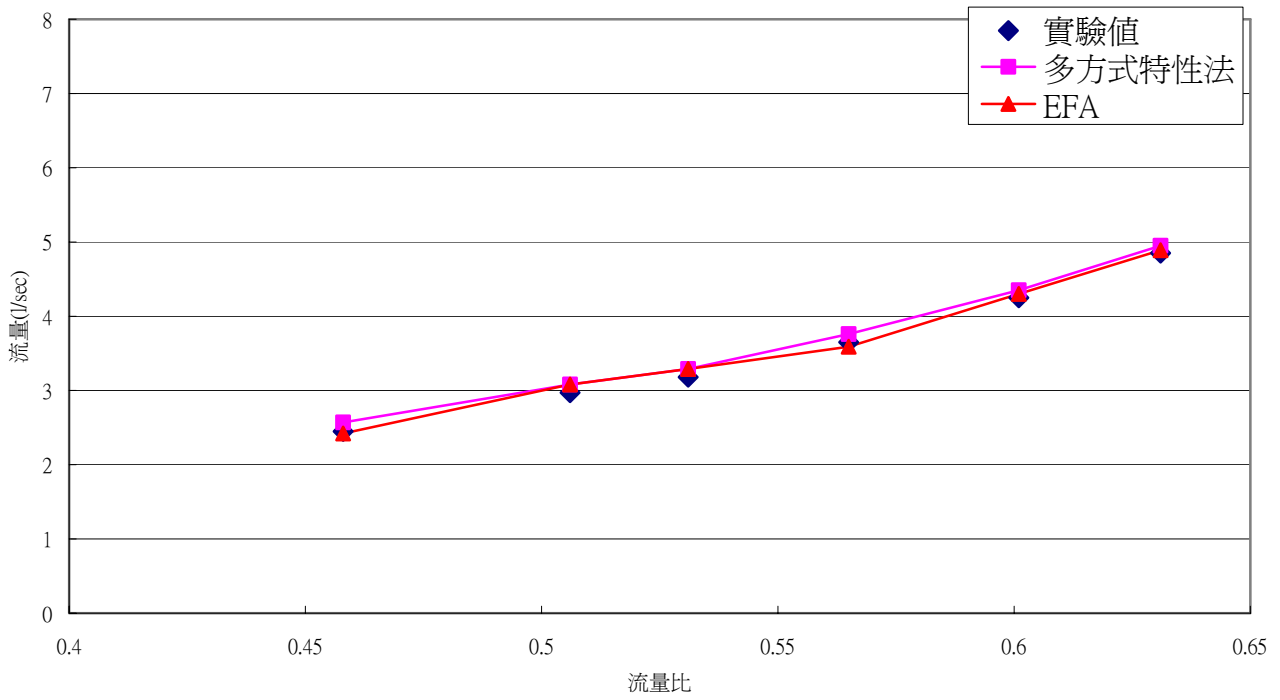

圖 4.19 非等寬分流渠道配置及尺寸圖

(摘自何，2003)

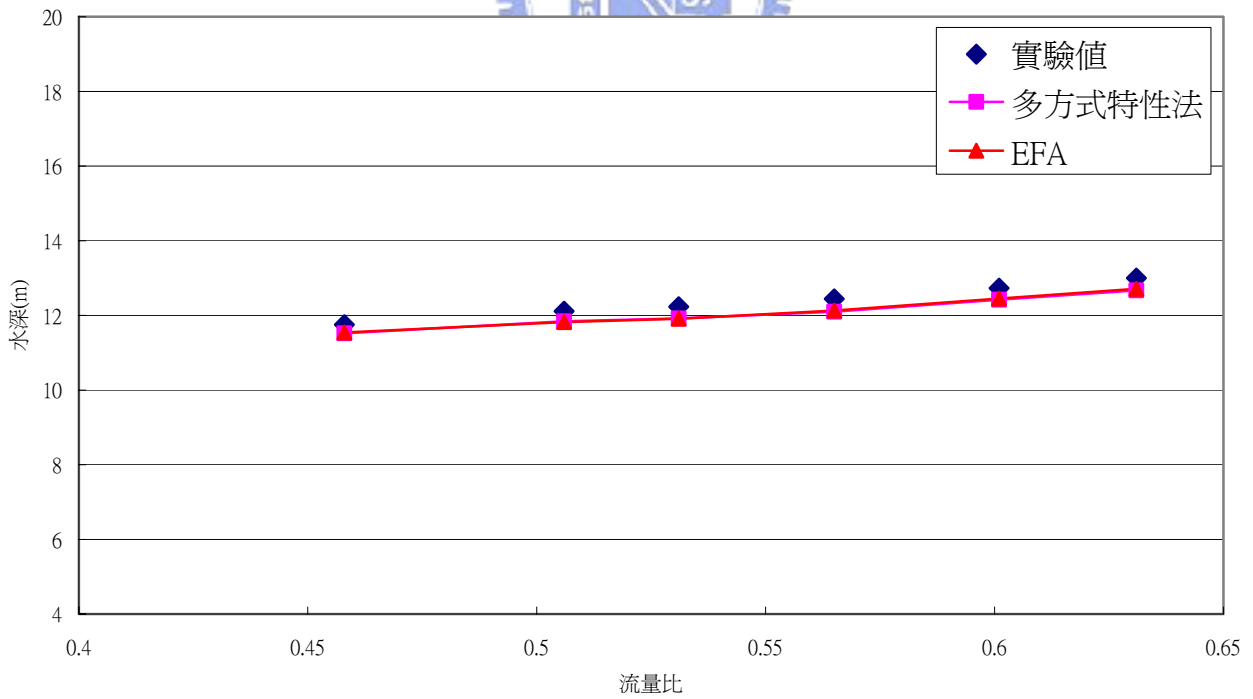
渠寬比 1/2

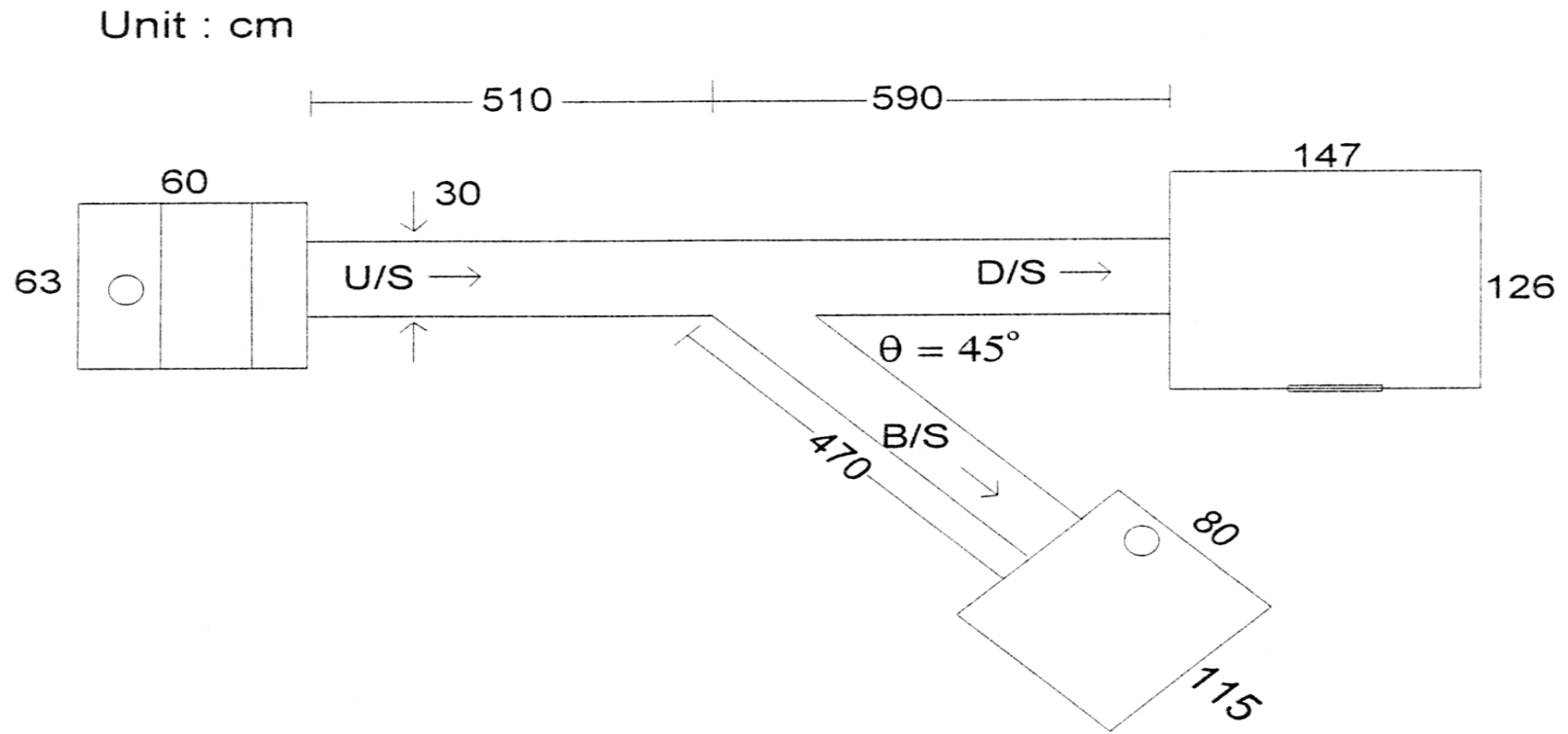
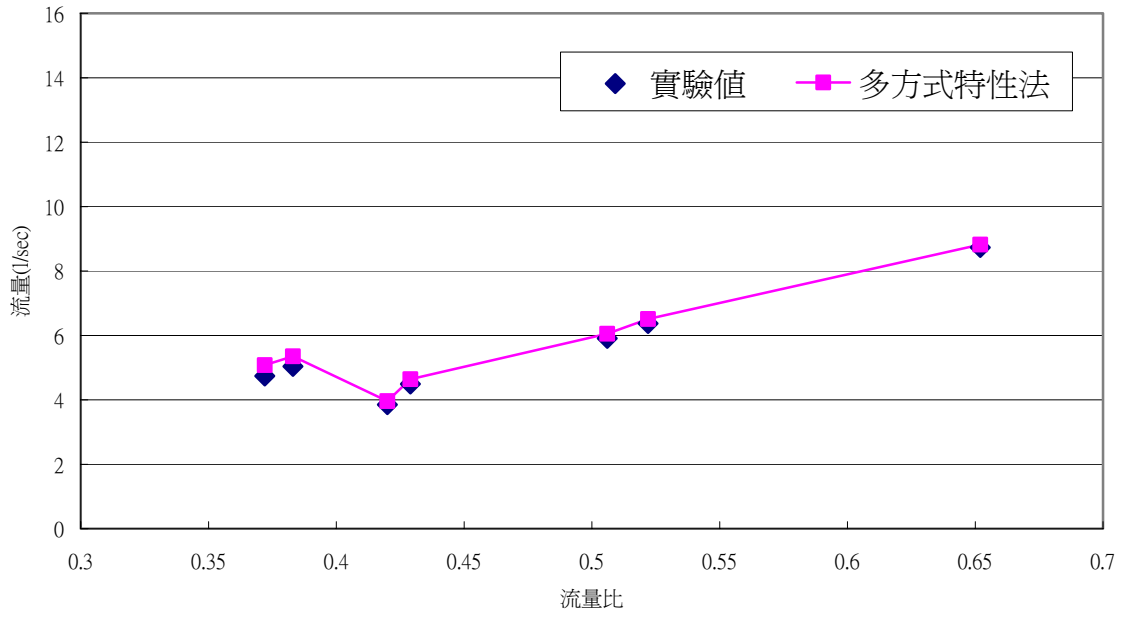

渠寬比 1/3



圖 4.20 分流角度 45 度主流下游流量比較圖

渠寬比 1/2



圖 4.21 分流角度 45 度主流上游水深比較圖

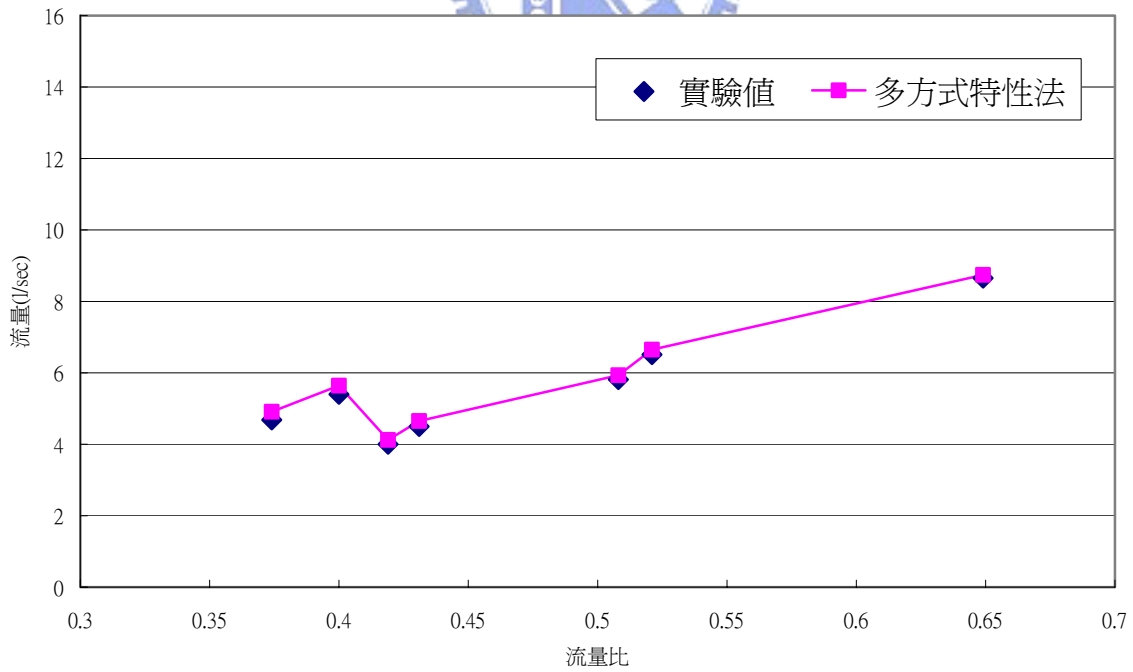

圖 5.1 合流渠道設置圖

(摘自 A. A. Khan, 2000)

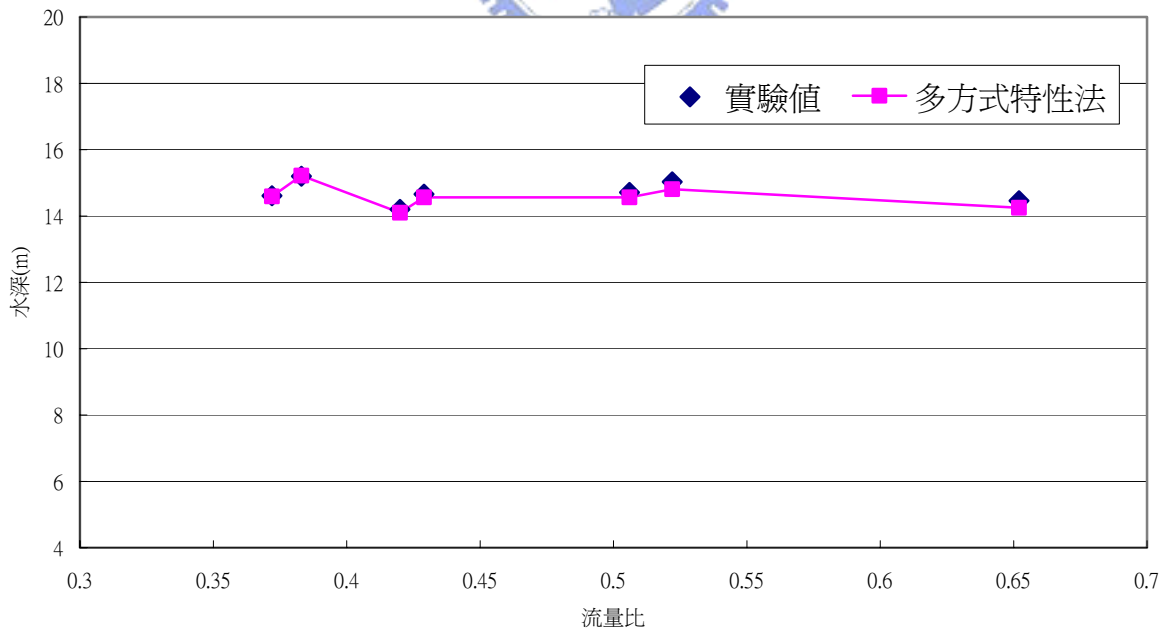
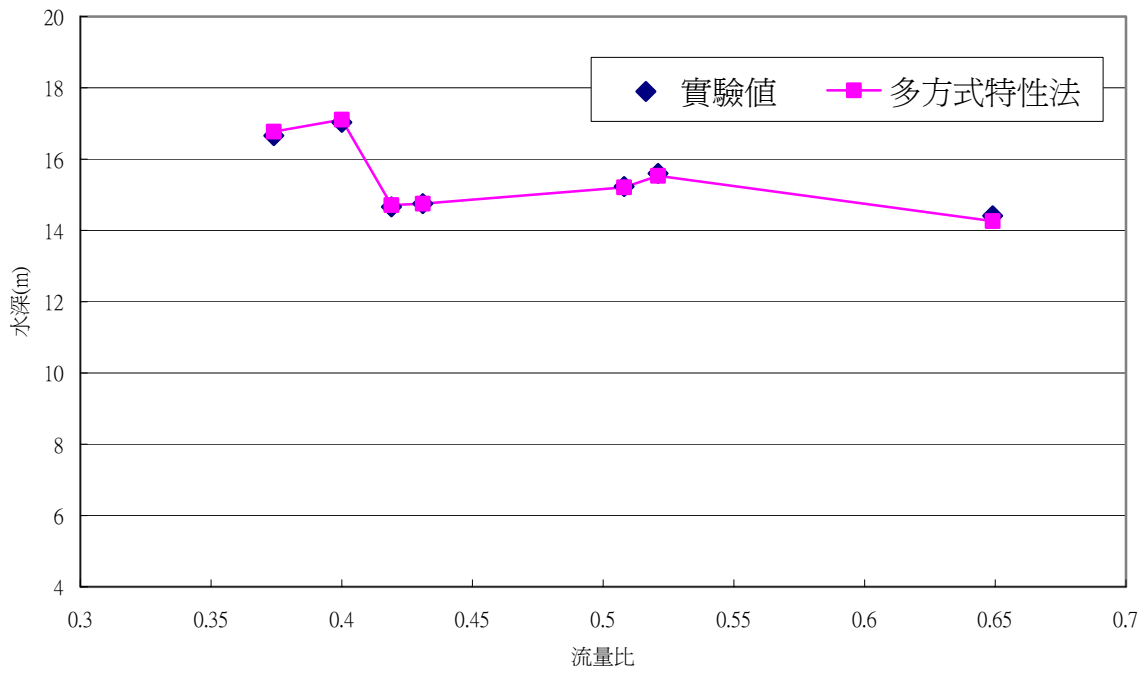

圖 5.2 定量流於合流主渠水深沿程圖

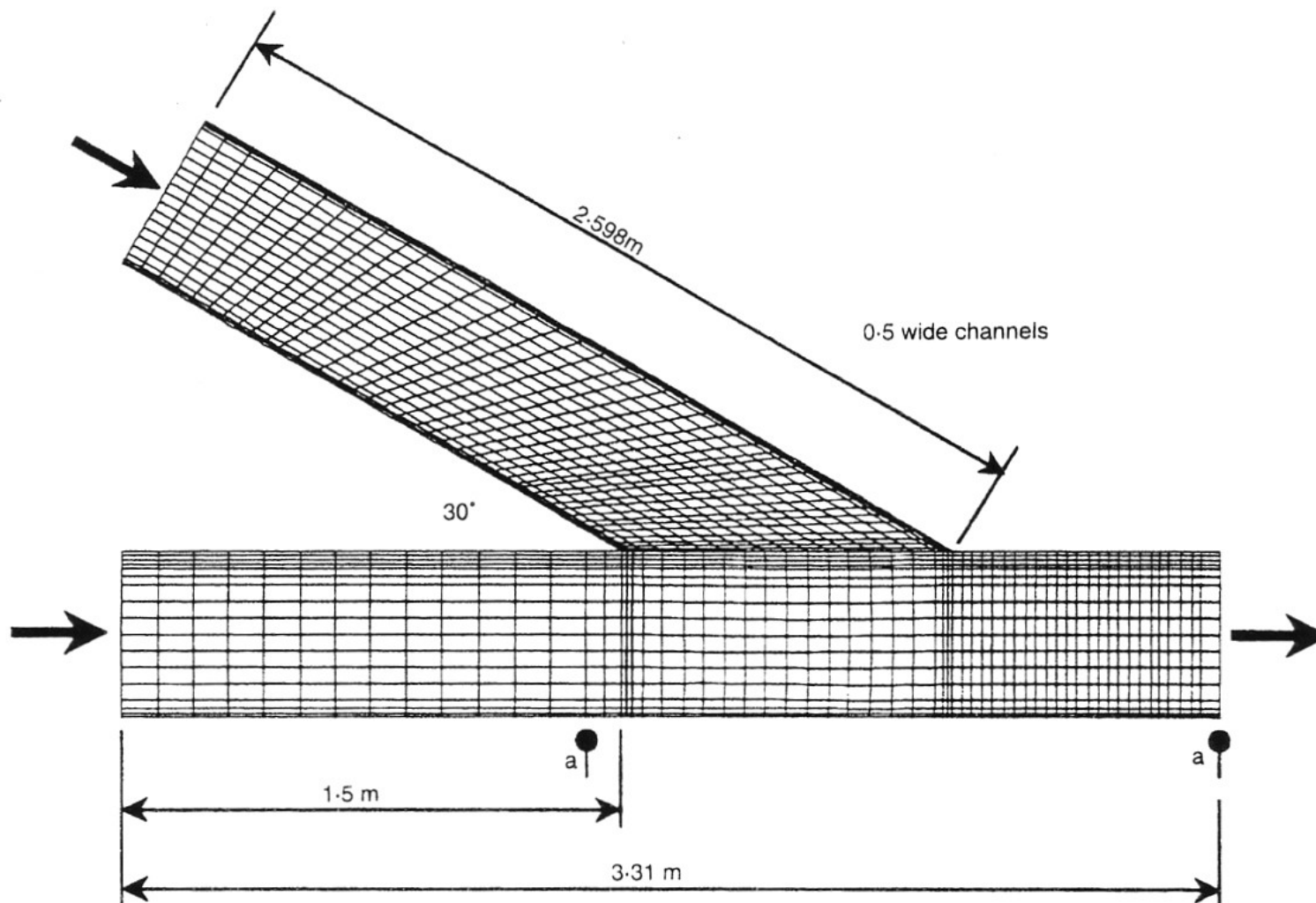

圖 5.3 定量流於合流主渠流量沿程圖



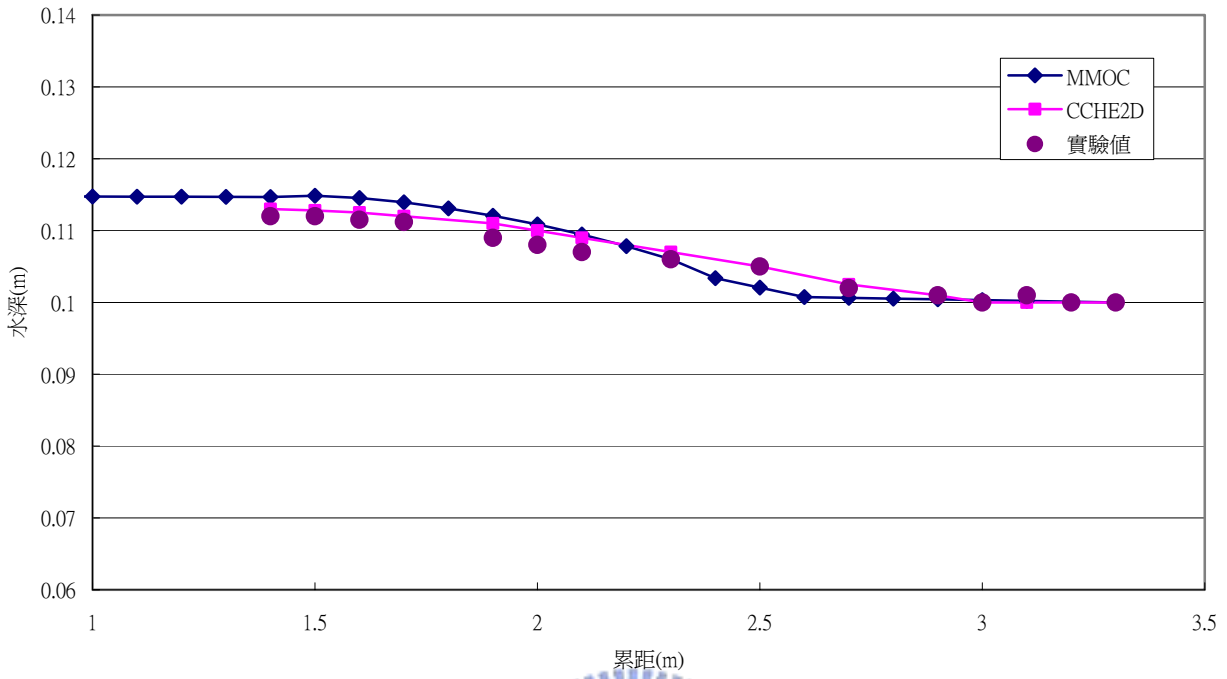

圖 5.4 定量流於合流支渠水深沿程圖

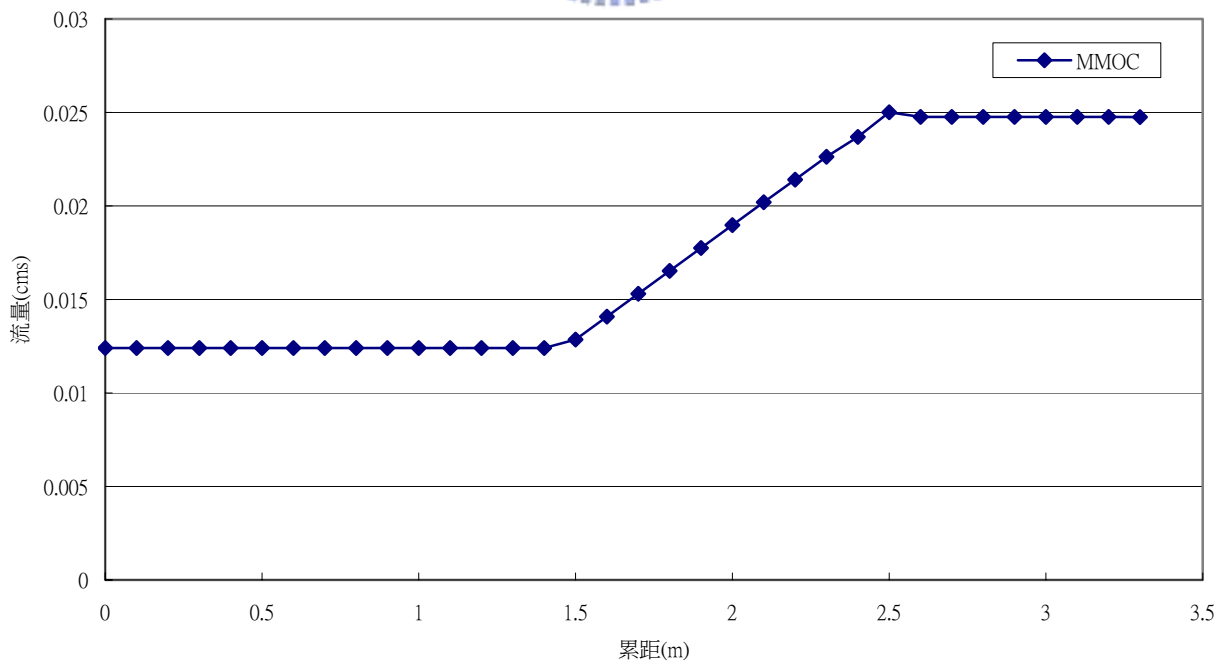

圖 5.5 定量流於合流支渠流量沿程圖

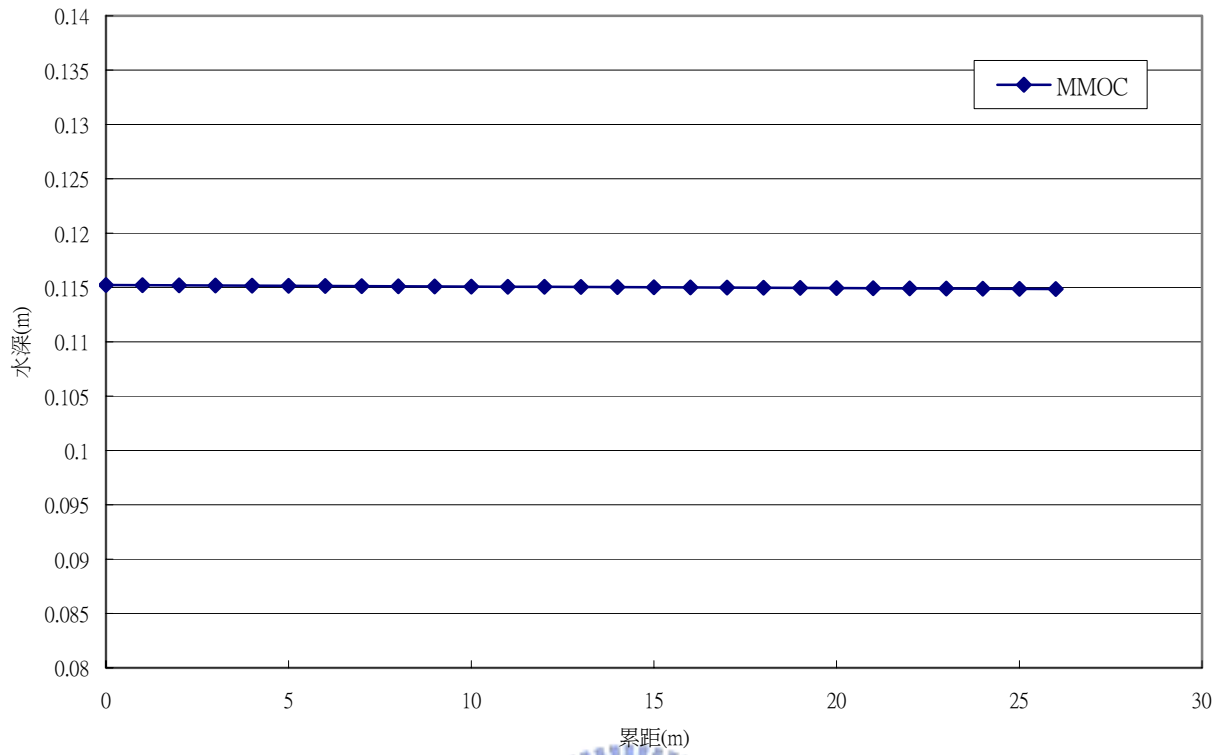

圖 5.6 合流主渠流量延時歷線圖

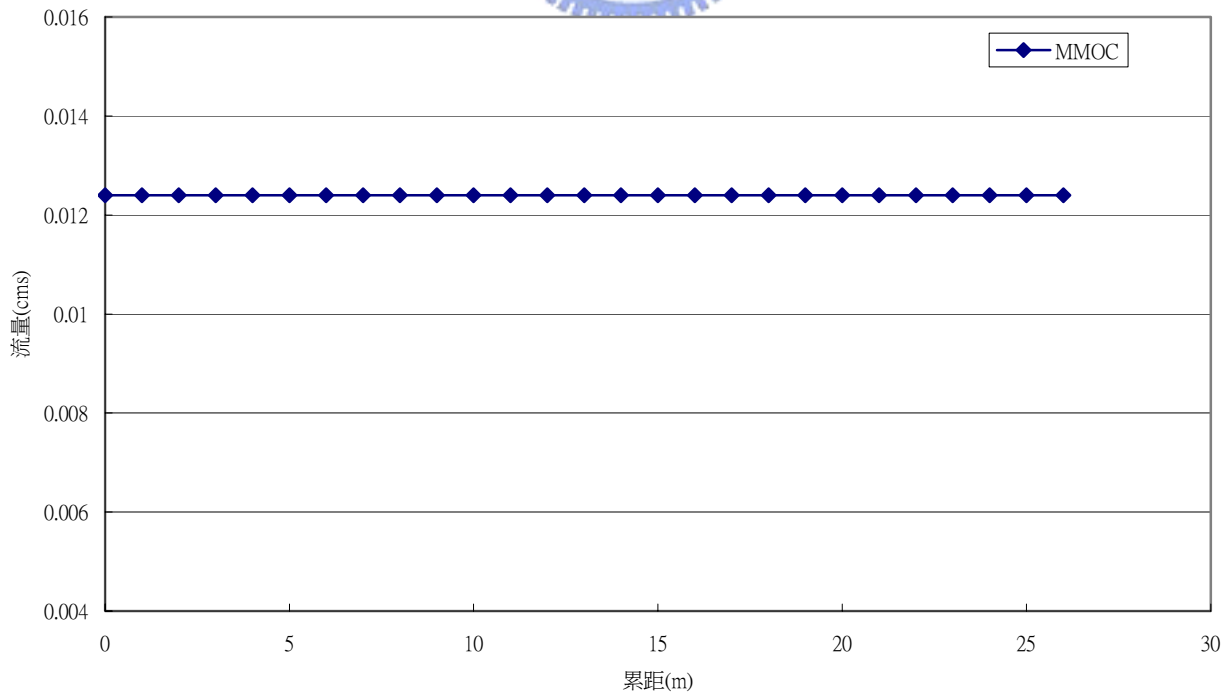

圖 5.7 合流主渠流速延時歷線圖

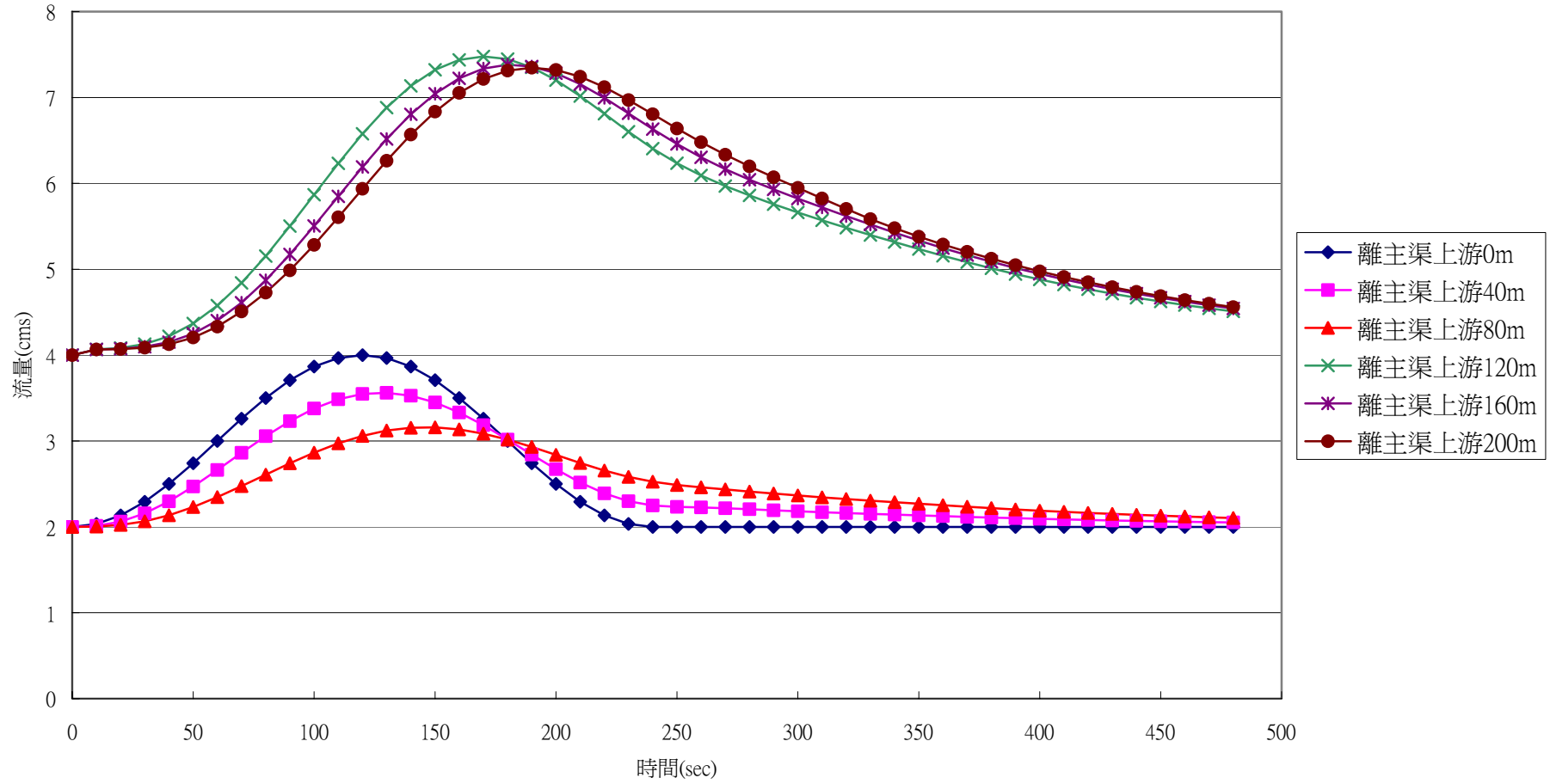

圖 5.8 合流主渠水深延時歷線圖

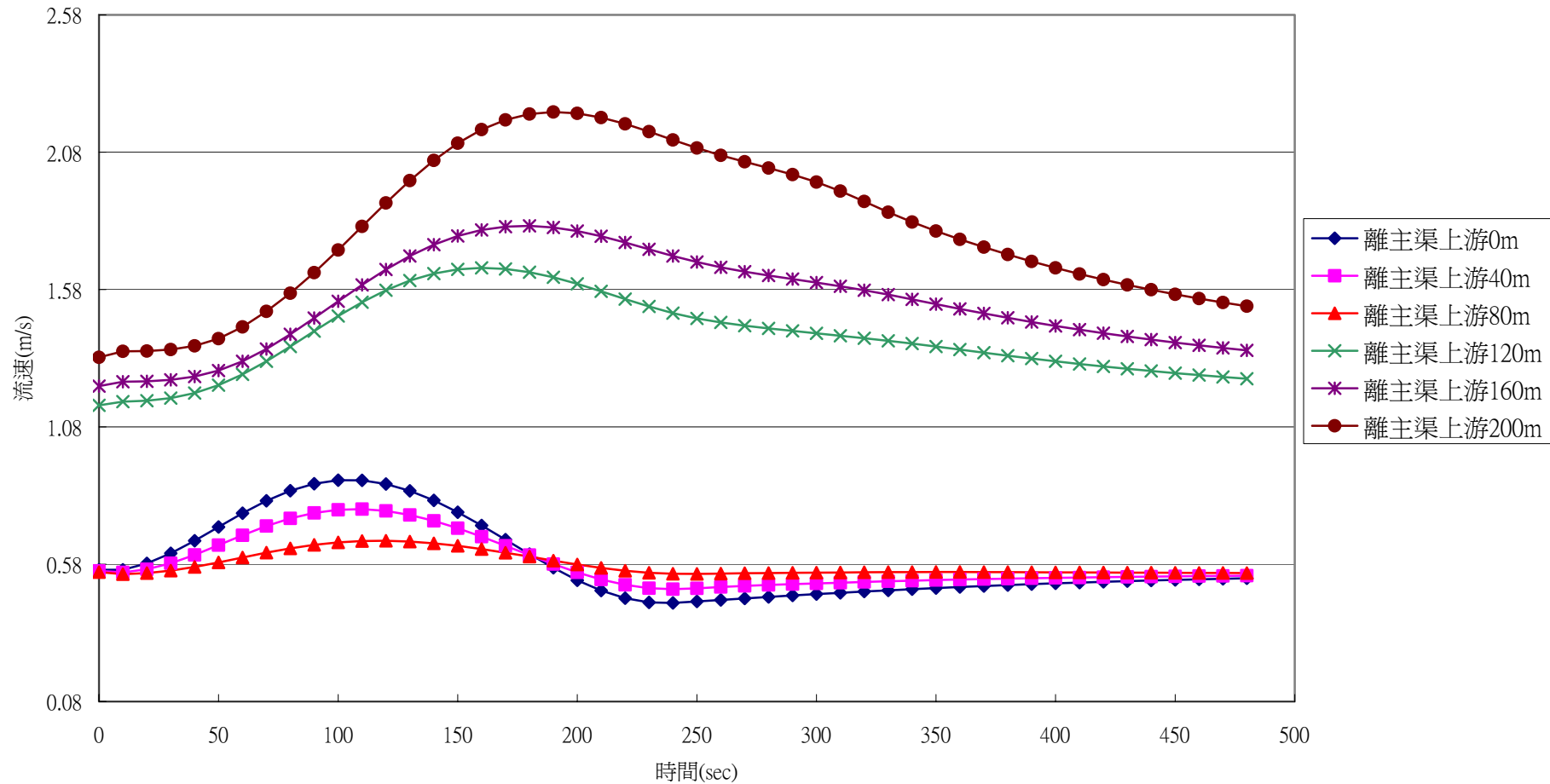

圖 5.9 定量流於分流主渠水深沿程圖

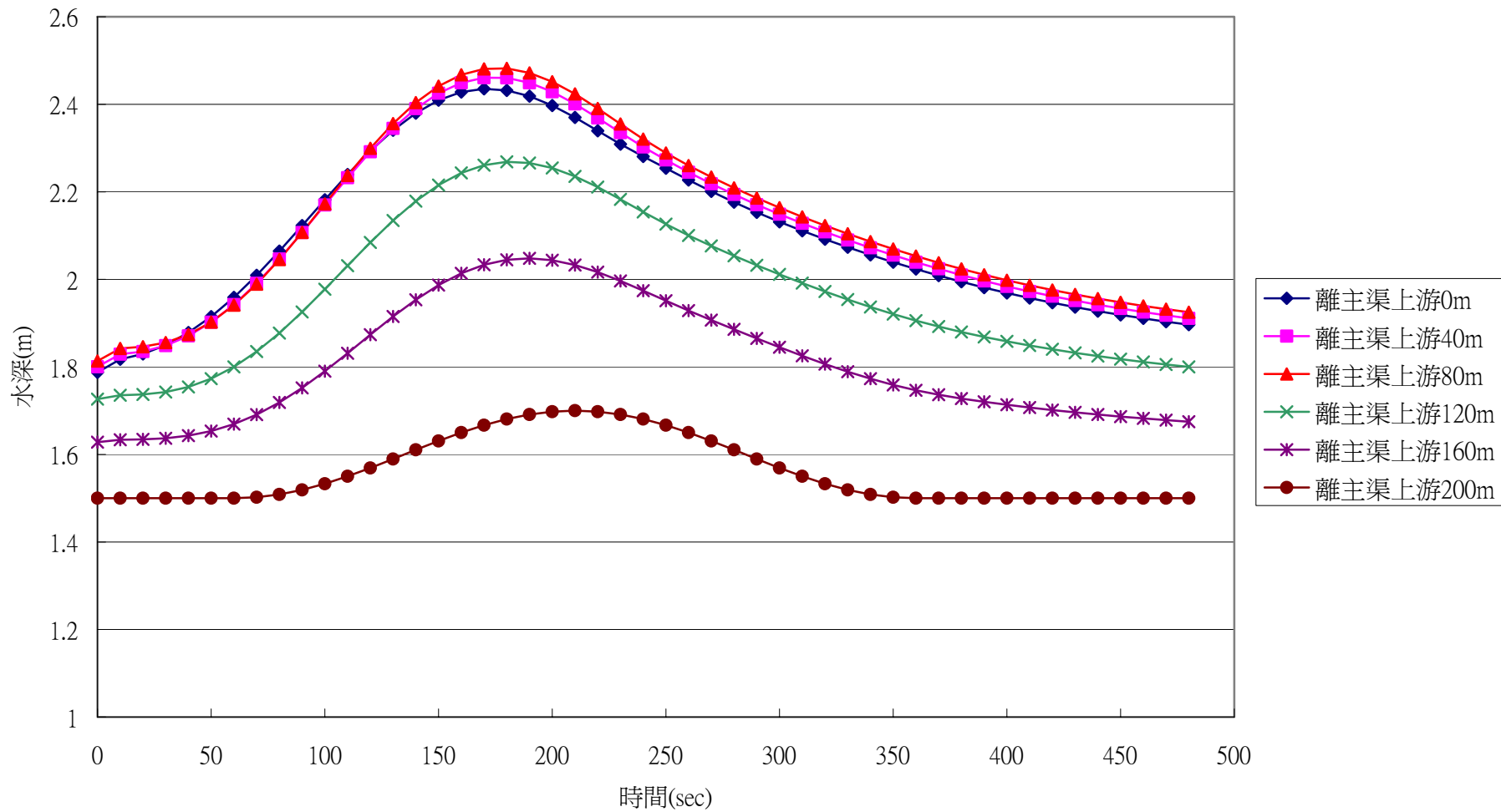

圖 5.10 定量流於分流主渠流量沿程圖

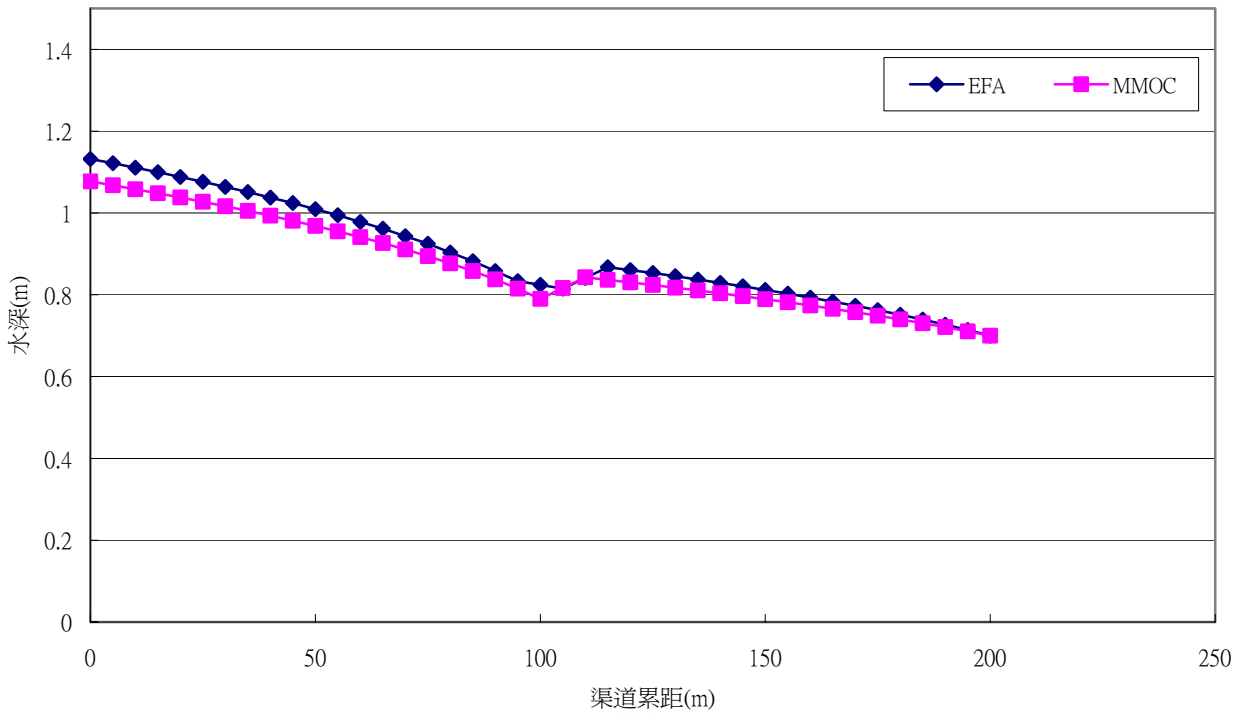

圖 5.11 定量流於分流支渠水深沿程圖

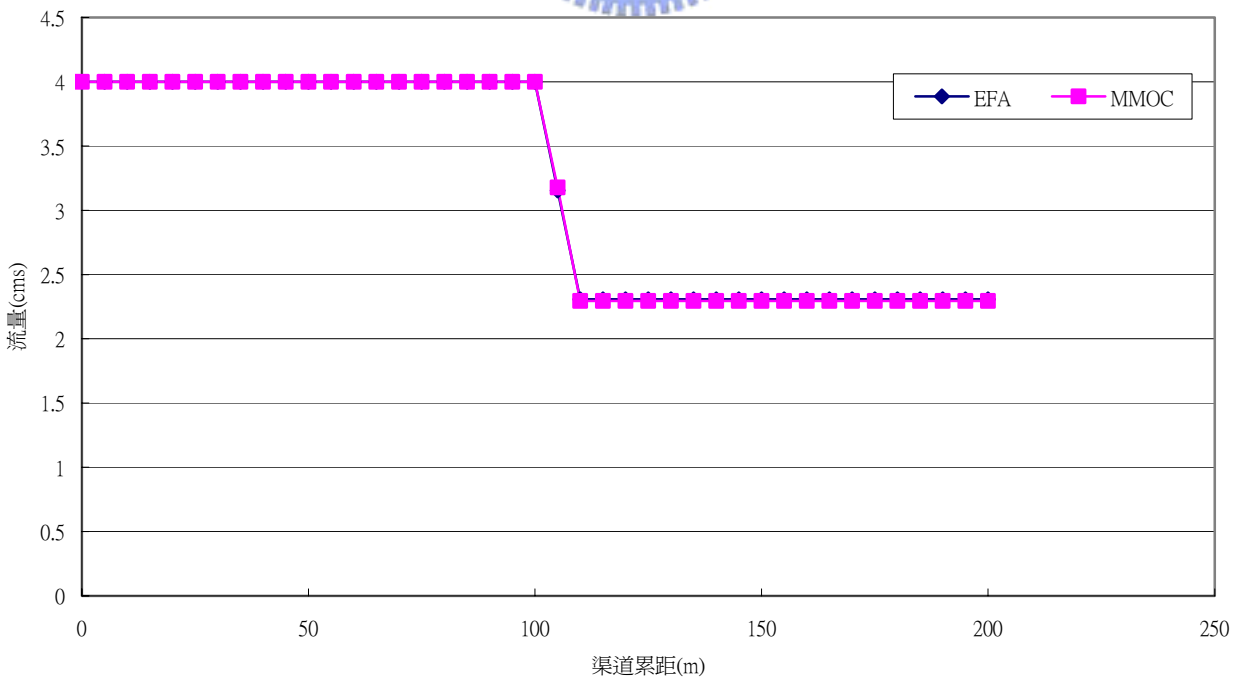

圖 5.12 定量流於分流支渠流量沿程圖

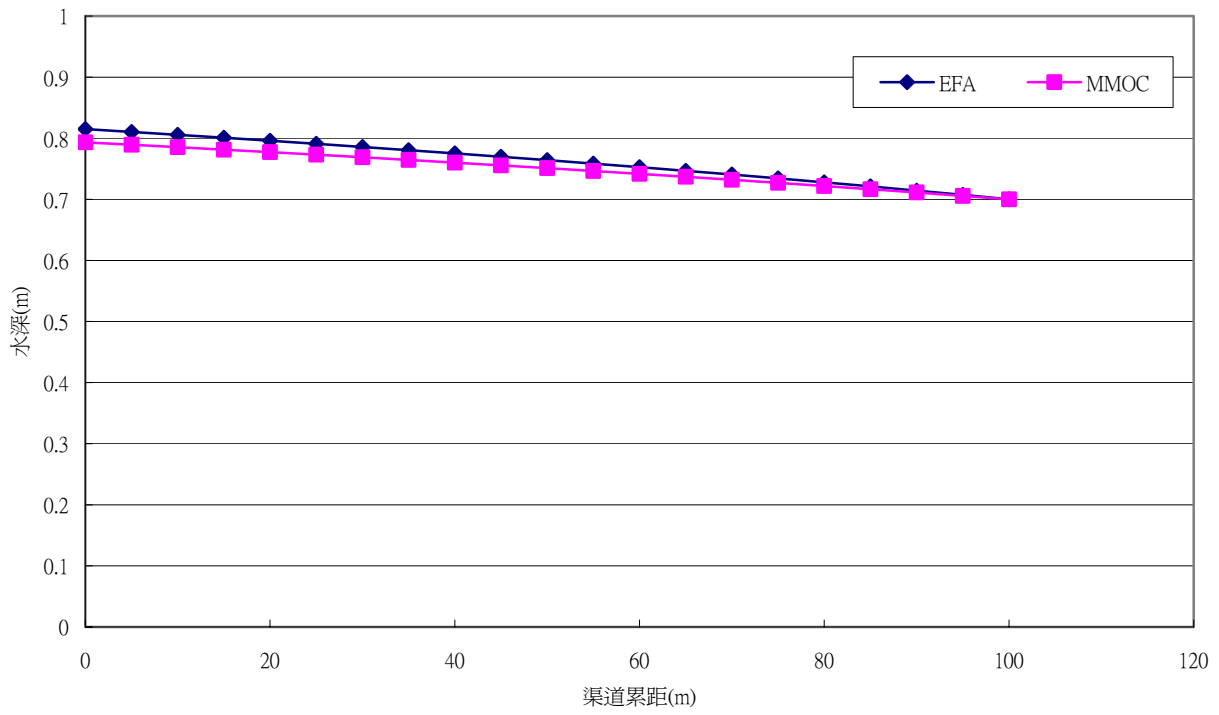

圖 5.13 分流主渠流量延時歷線圖

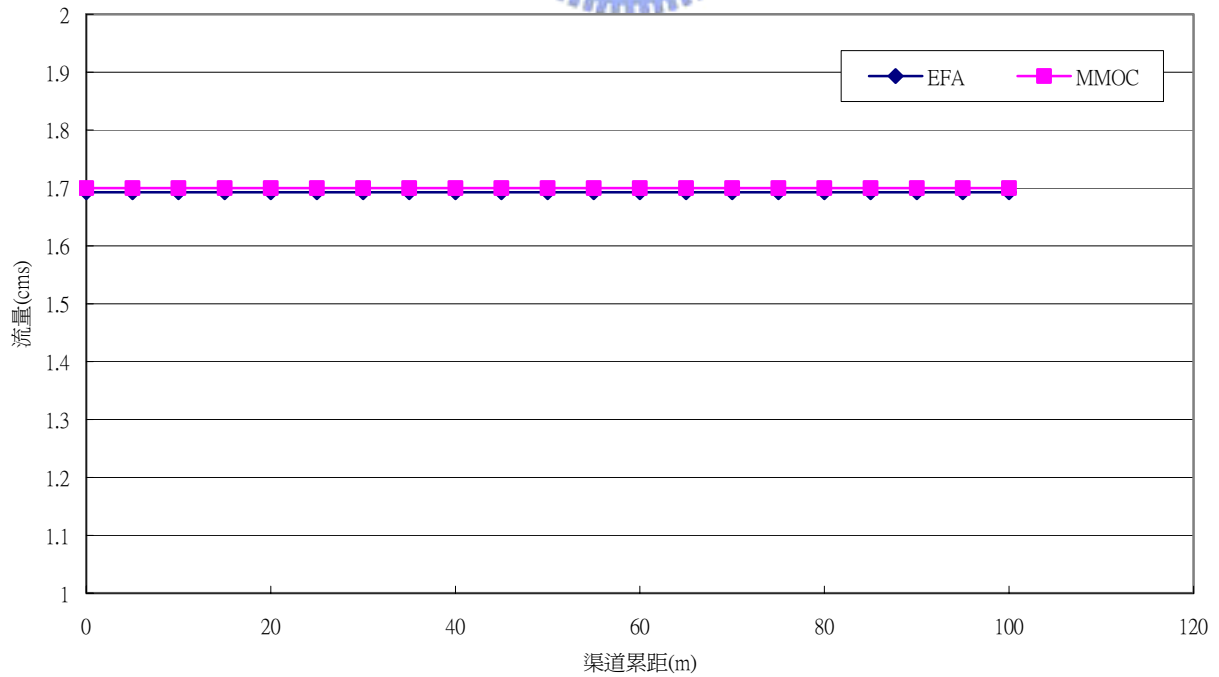
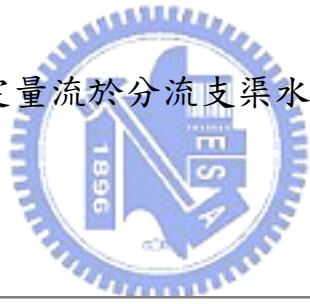

圖 5.14 分流主渠流速延時歷線圖



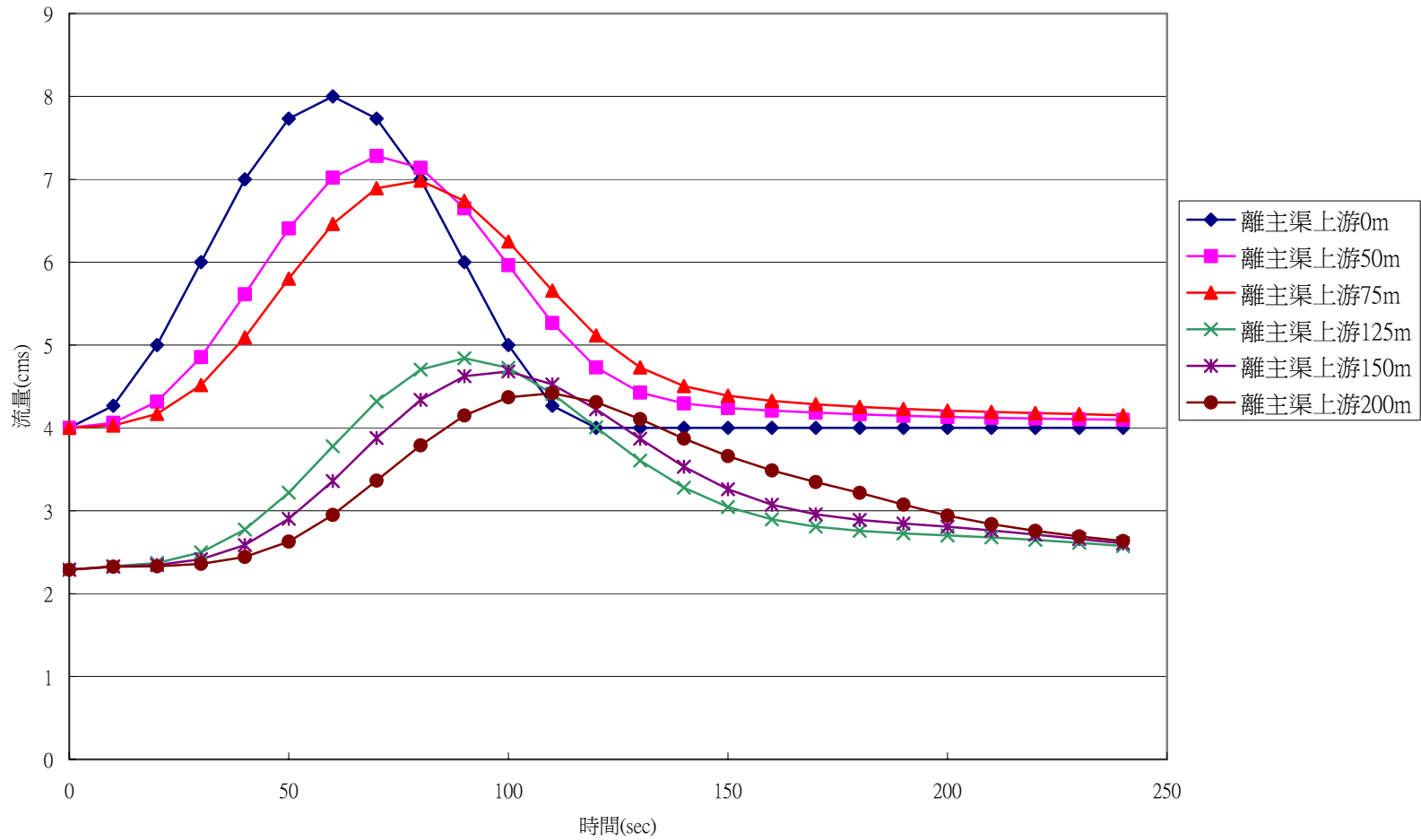

圖 5.15 分流主渠水深延時歷線圖

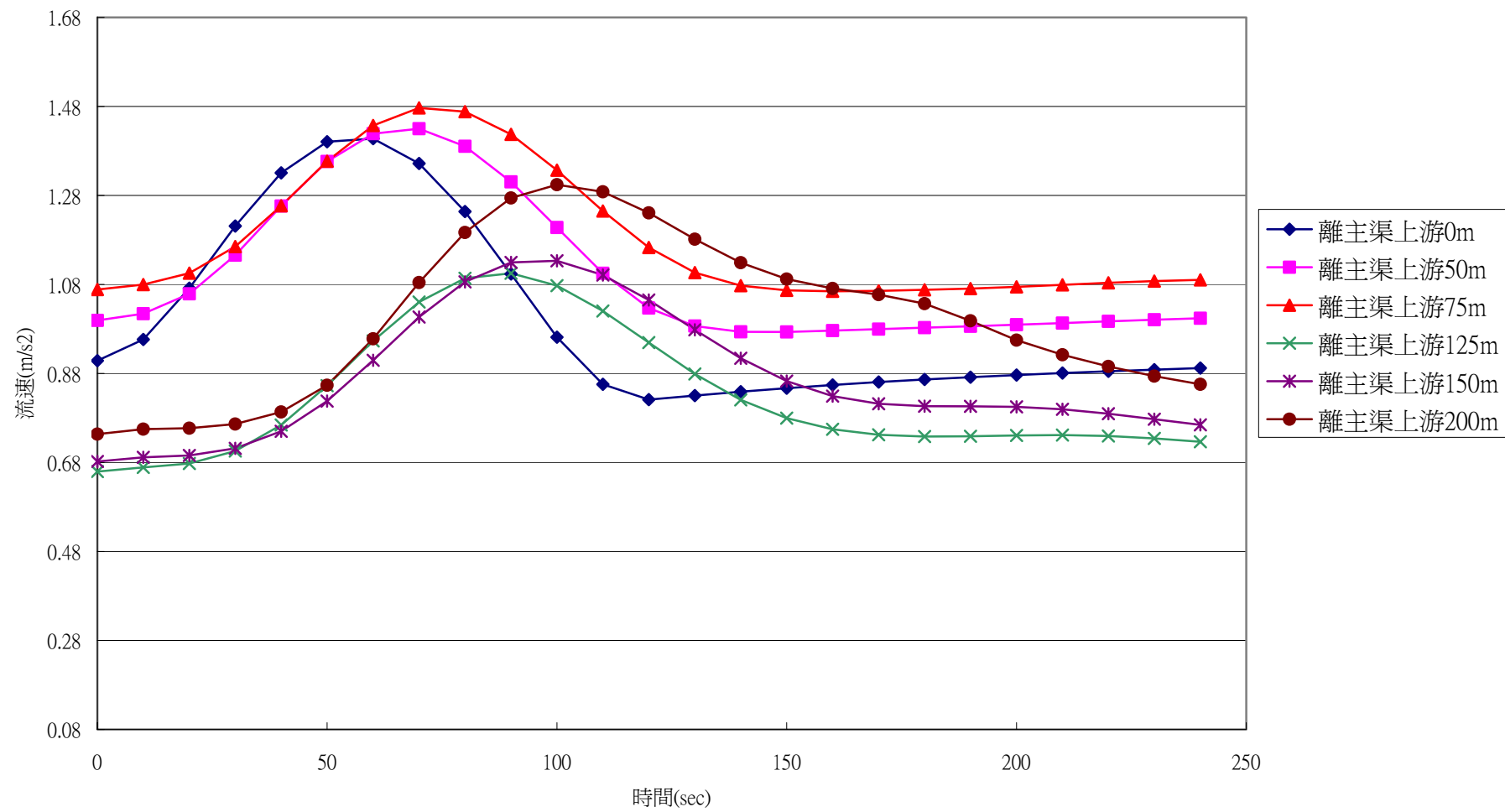

圖 5.16 主渠上游和支流斷面圖

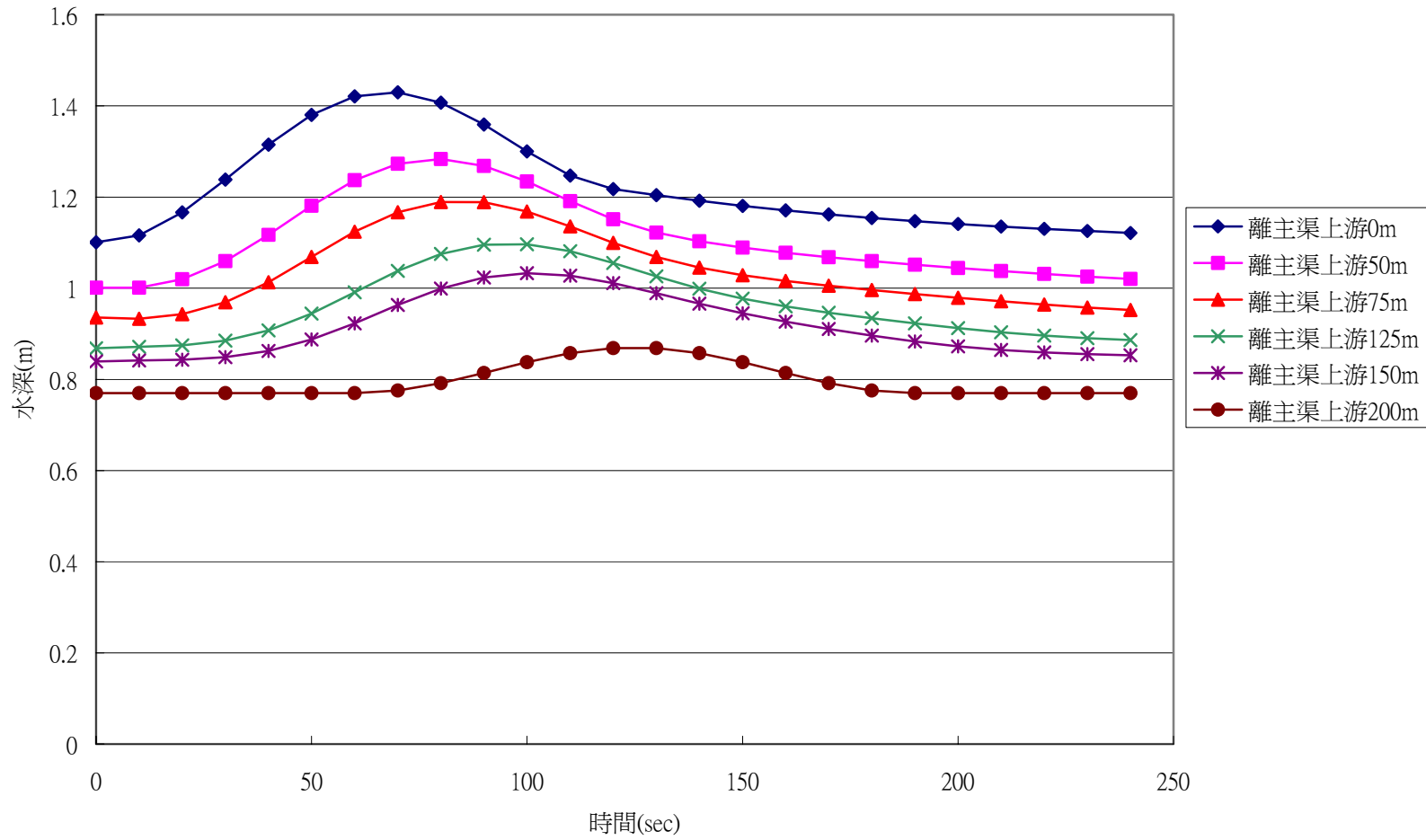

圖 5.17 主渠下游斷面圖

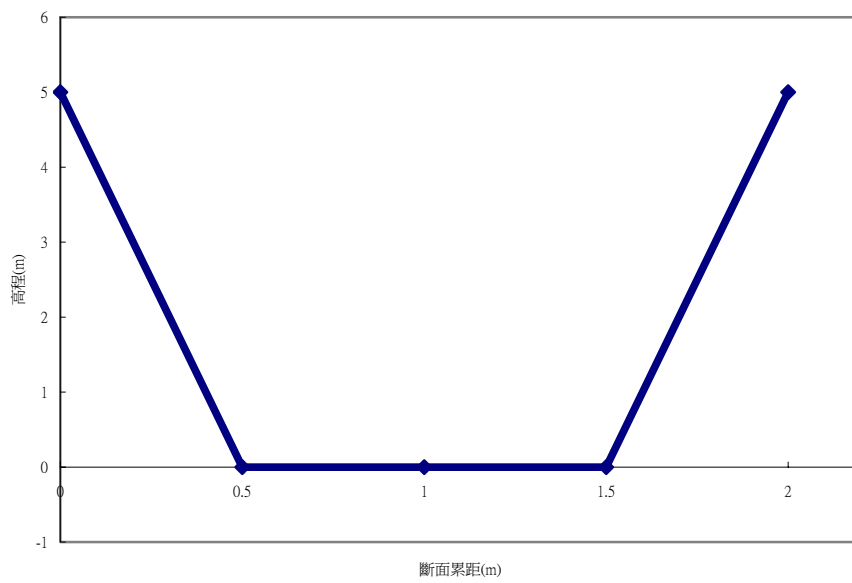

圖 5.18 非矩形渠道主渠流量延時歷線圖

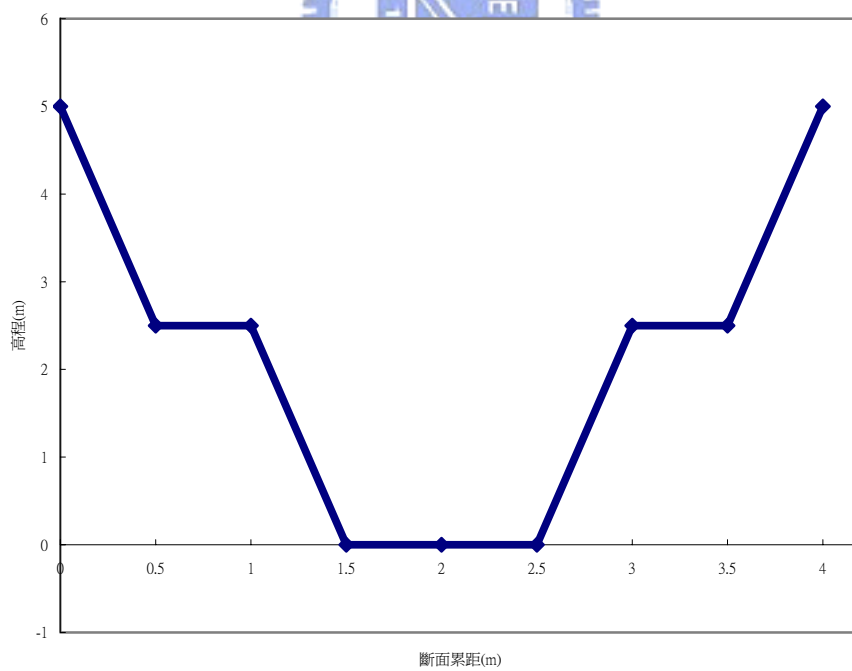

圖 5.19 非矩形渠道主渠流速延時歷線圖

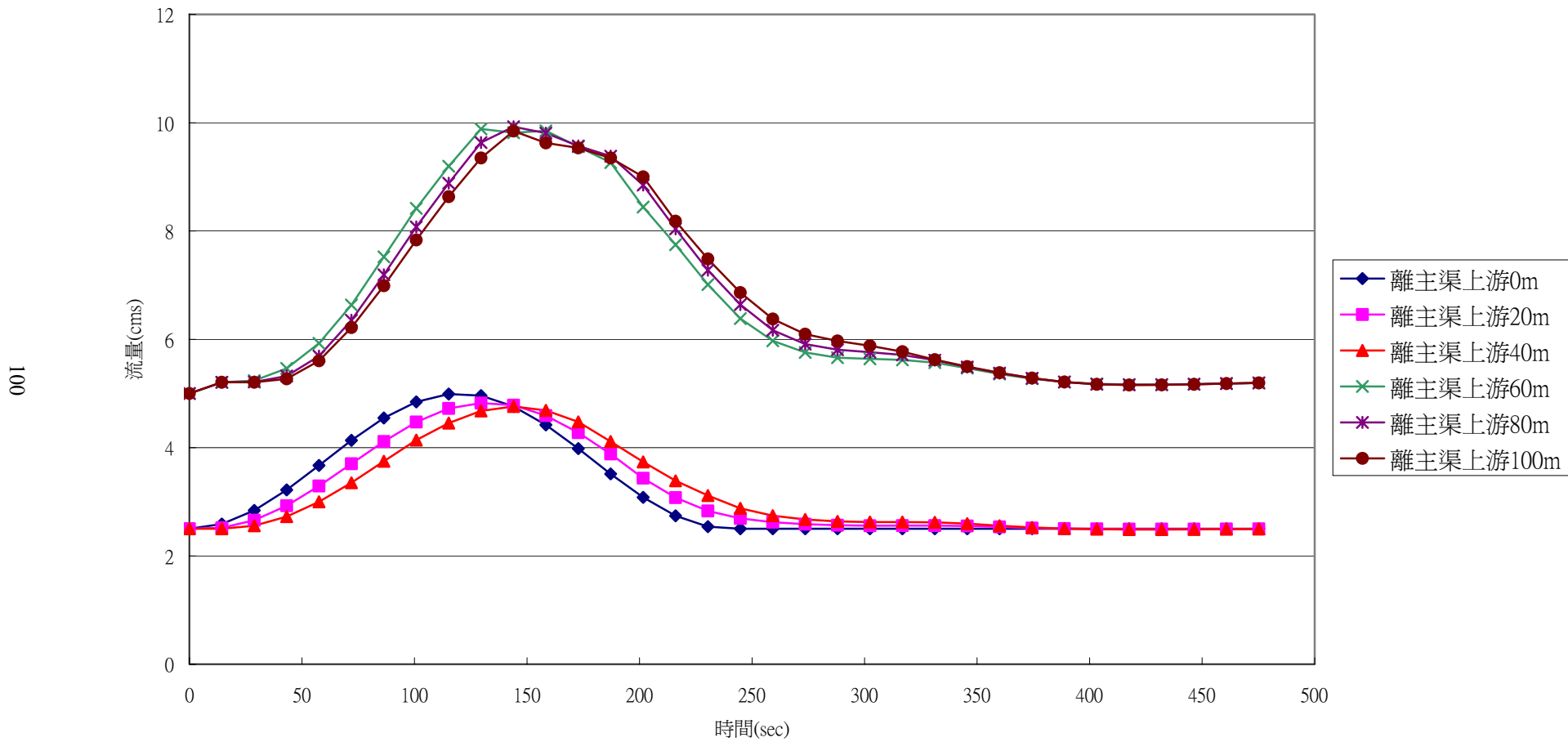
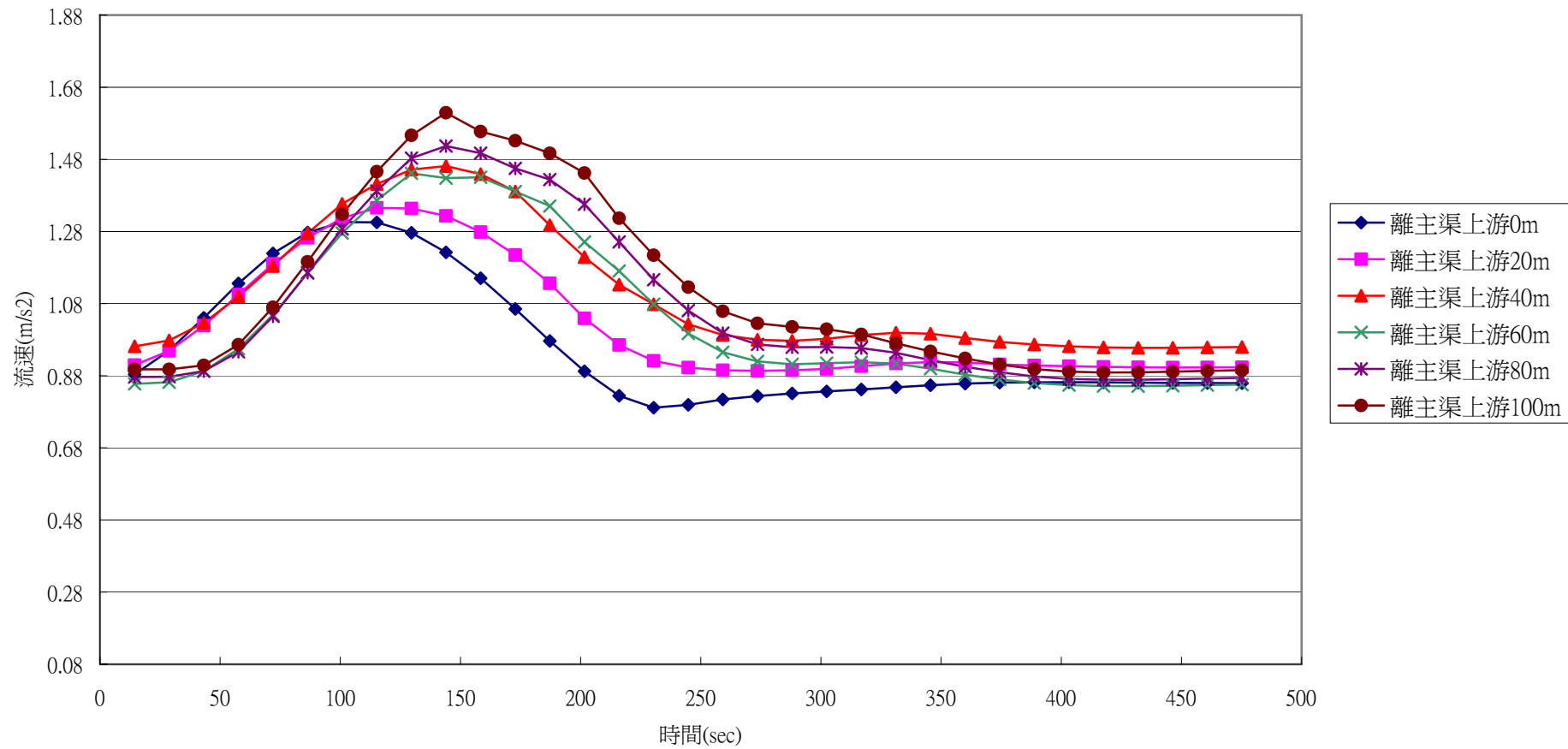
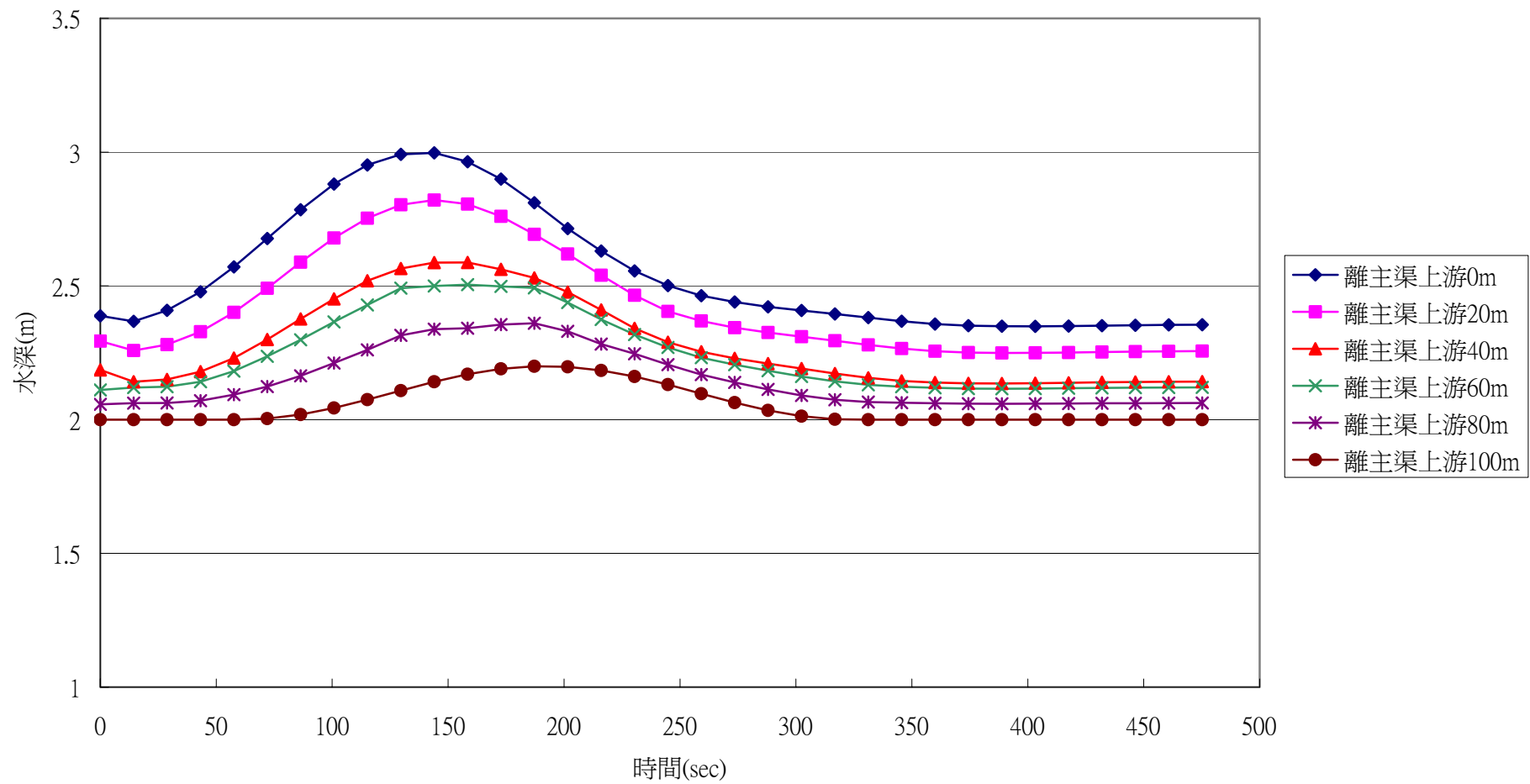

圖 5.20 非矩形渠道主渠水深延時歷線圖