



---

## PROJECT 02

後設空間 城市中的低空飛行  
Metaspaces\_Sky Stadium



後設空間 城市中的低空飛行  
**METASPACE** Sky Stadium

後設空間 城市中的低空飛行

討論的設計議題,著重於都市各種原本毫無相關的運作系統,尋找其背後微妙相互牽連的關係,並藉由重新組織”關係”的手段,創造一套新的都市運行概念,是為都市內在關聯之”界繫”。



## [ Metaspaces ]

### --->DATA MAPPING

a collection of observed urban phenomena

### --->PROTOTYPE

imported devices for intervention

## Sampling\_\_100 randomly chosen sites

## Mini-Scenario\_\_game rule

**SITE:** [ number ]

**Scenario title :** "title name"

**EOTM structure :** erasure / origination / transformation / migration

**Description :**

[**Erasure** is talking things away, making space.-

**Origination** is a point in time where something new begins to happen, origination sets something into the realm of the other, it is the basis reaction.-

**Transformation** indicates a continuous change between two states of an object or situation, a change with a beginning and an end.-

**Migration** describes things moving from one point to another, things that leave and don't return, of which sometimes traces remain.]

## Operation Field\_\_diagram

**Diagram making :** erasure / origination / transformation / migration

**Description :** simulation of possible realities and interactions between those phenomena

## PROTOTYPE\_\_imported devices for intervention



# Sampling

100 randomly chosen sites

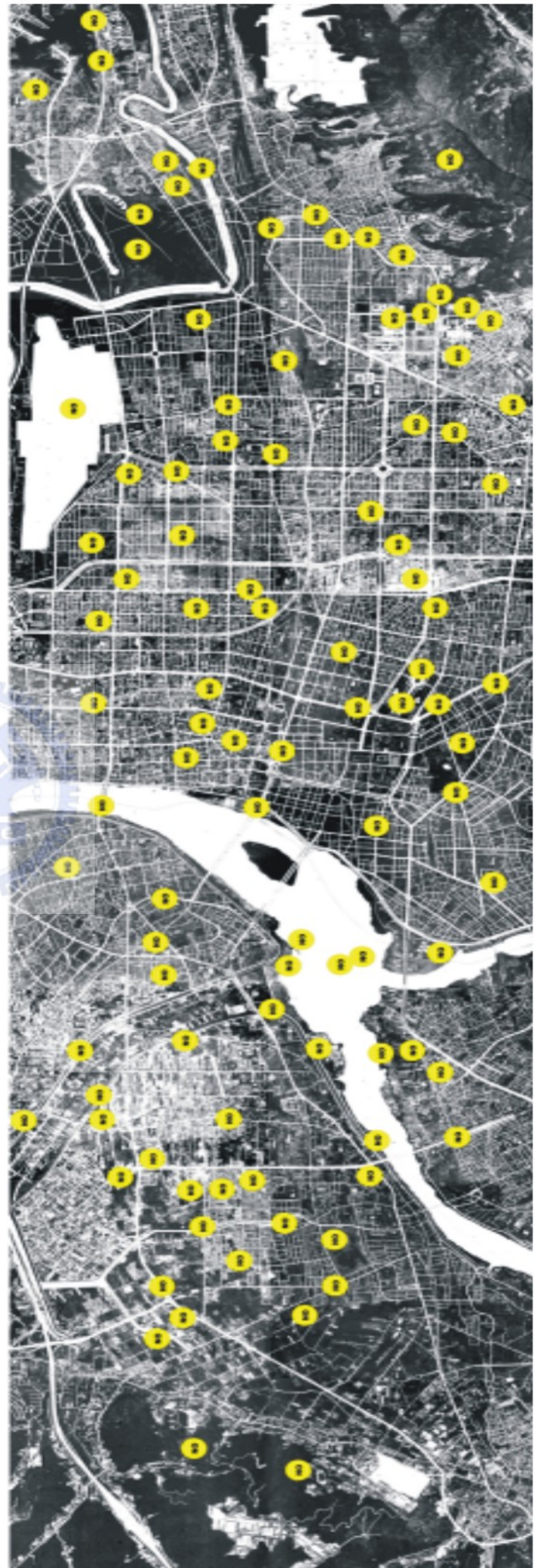



**mini-scenario**





E37:河濱農田不見了(被徵收)



O37:灌溉用打水機開始荒廢

**E T O M**

T37:從前灌溉用的打水機器變成現在運動後清潔的水源

M37:運動後的人們隨著自行車網路連接至成市內部網路



**E** 37 河濱農田不見了(被徵收)

**O** 37 灌溉用打水機開始荒廢

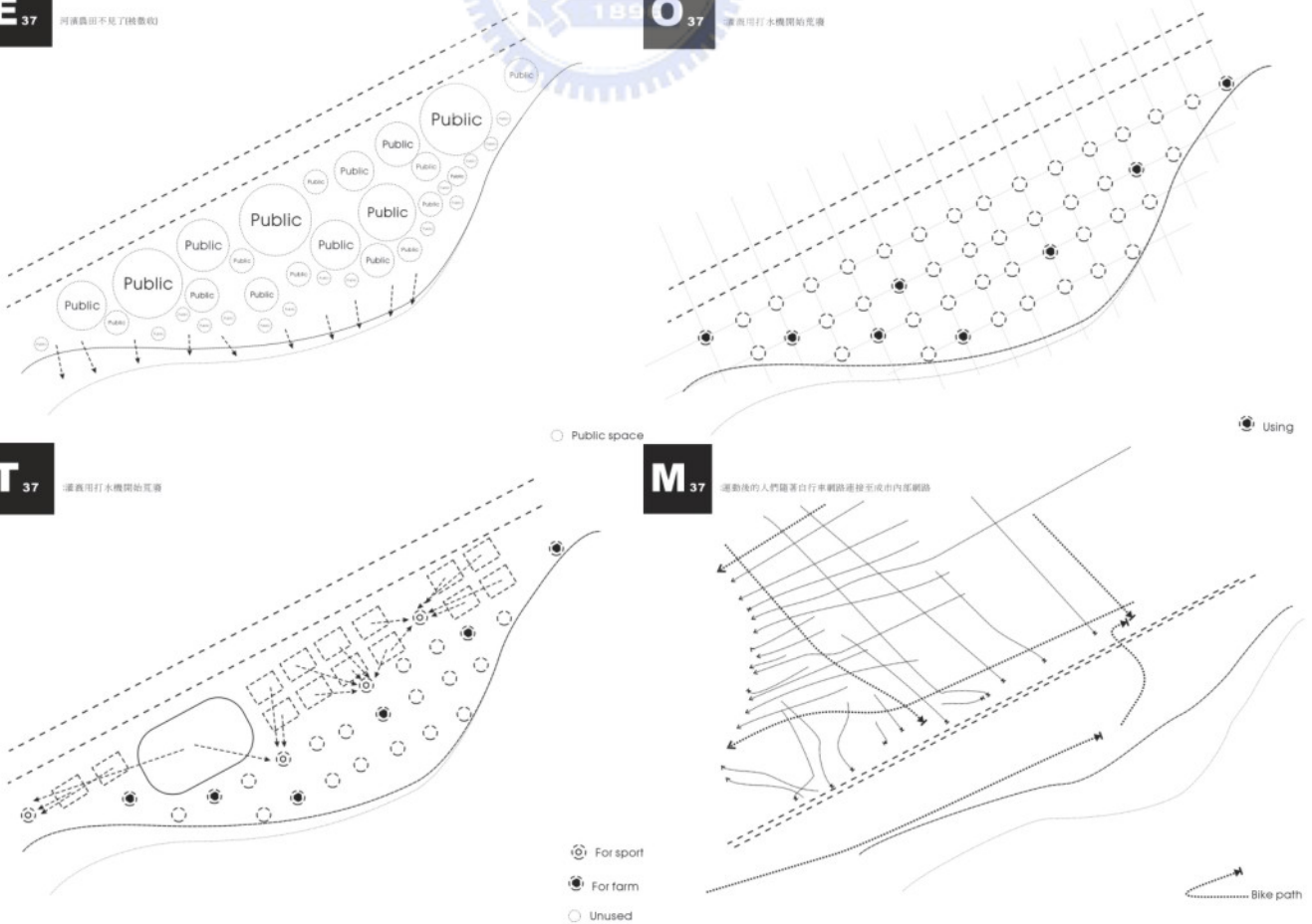

**T** 37 灌溉用打水機開始荒廢

**M** 37 運動後的人們隨著自行車網路連接至成市內部網路





E42:環河道路系統部份封閉



O42:捷運路線開始穿越河底

T42:堤防邊穩固地基的水泥補強平台,變成另一塊河濱開放空間

**E**  
**T**

M42:隨著都市擴張,MRT跟著成長,帶動未來許多可預期與不可預期的變化



台北捷運路網  
民國100年

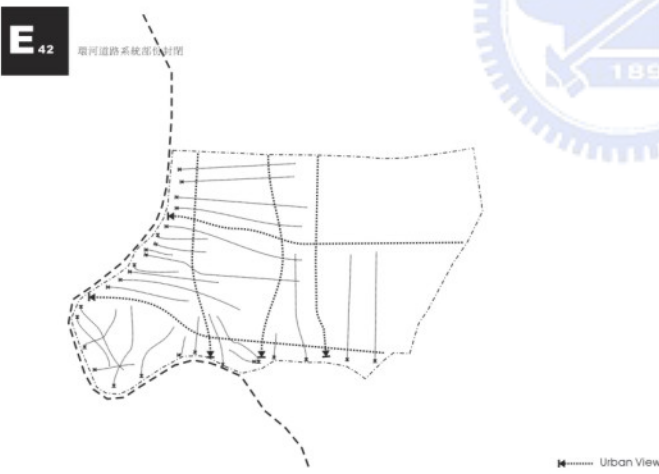

**E**  
42 環河道路系統部份封閉

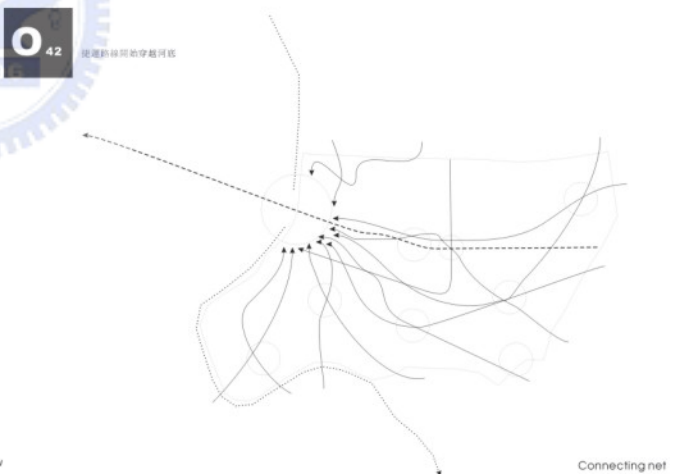

**O**  
42 捷運路線開始穿越河底

Urban View

Connecting net

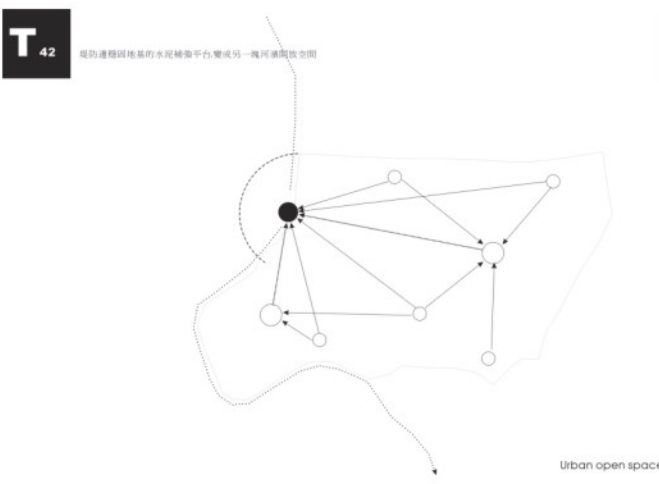

**T**  
42 堤防邊穩固地基的水泥補強平台,變成另一塊河濱開放空間

Urban open space

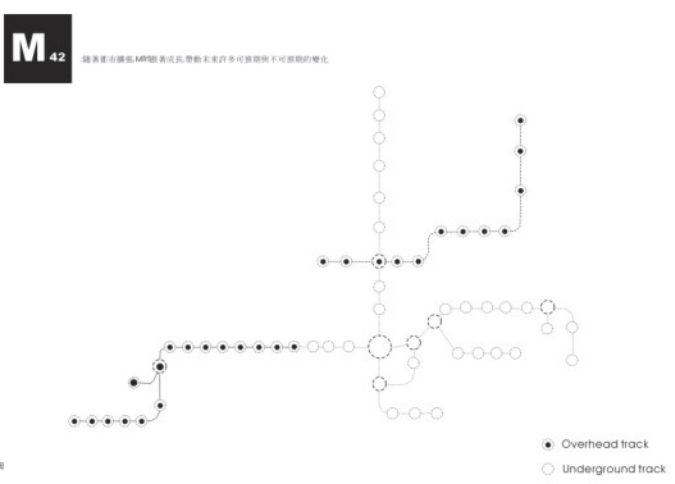

**M**  
42 隨著都市擴張,MRT跟著成長,帶動未來許多可預期與不可預期的變化

● Overhead track  
○ Underground track



E72:人行道被向下挖除

T72:地下道變成是明休閒練舞的地方



O72:行人在廣場聚集

M72:家中的舊家具被搬來當成練舞之後休息整理儀容的設施

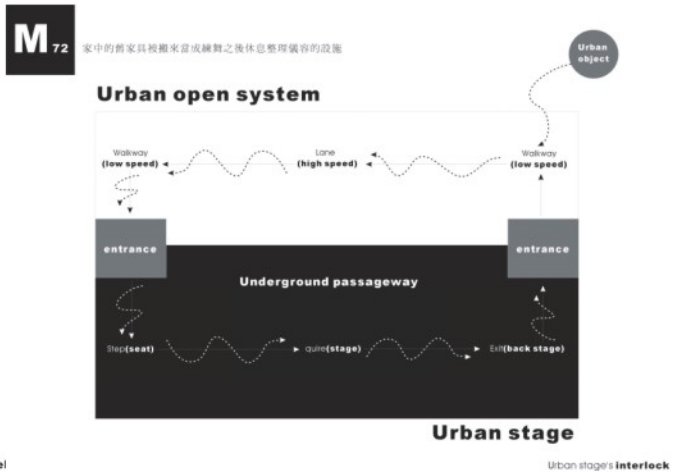
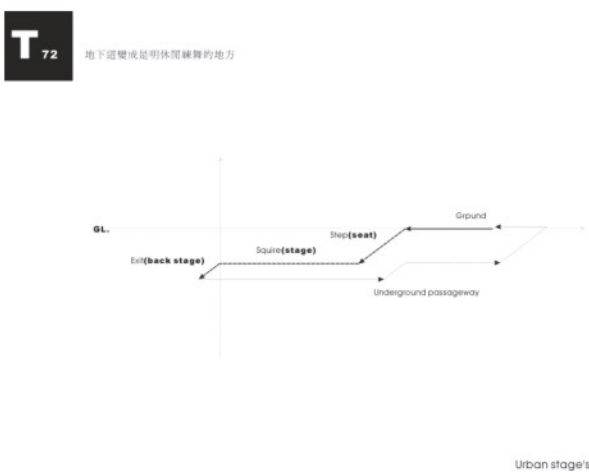
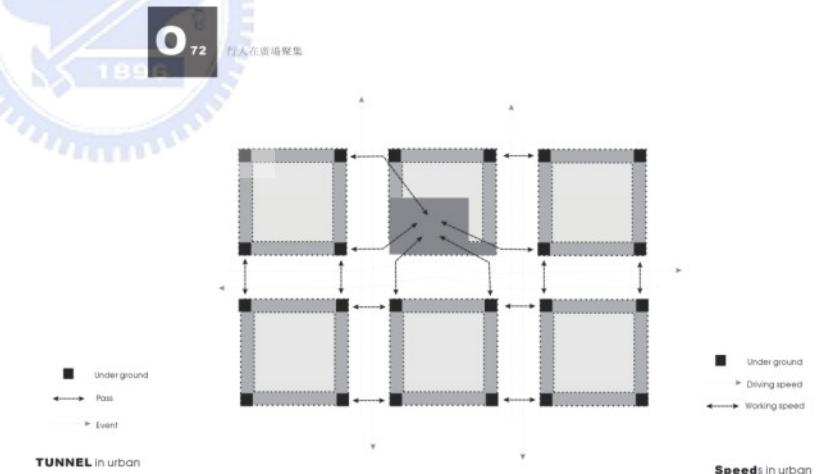
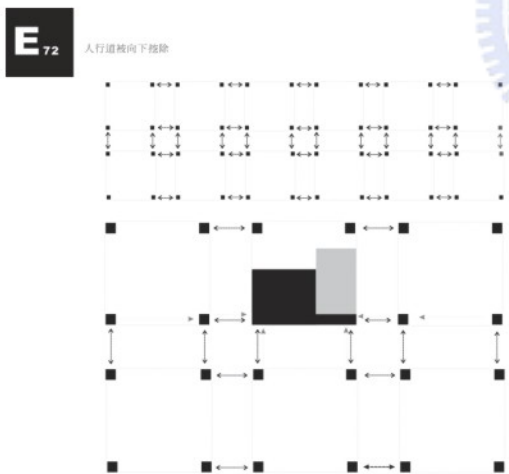
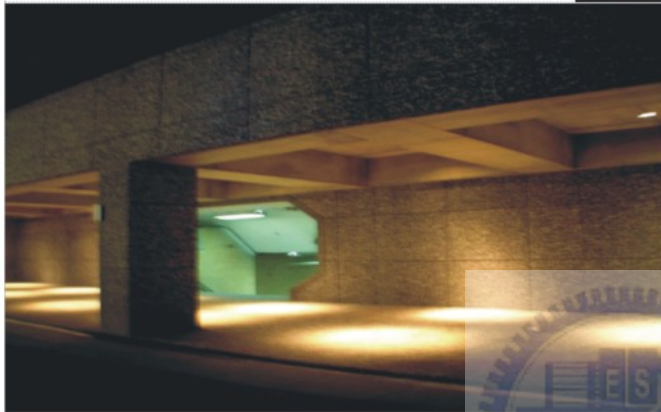



M 72

家中的舊家具被搬來當成練習之後休息整理儀容的設施

### Urban open system

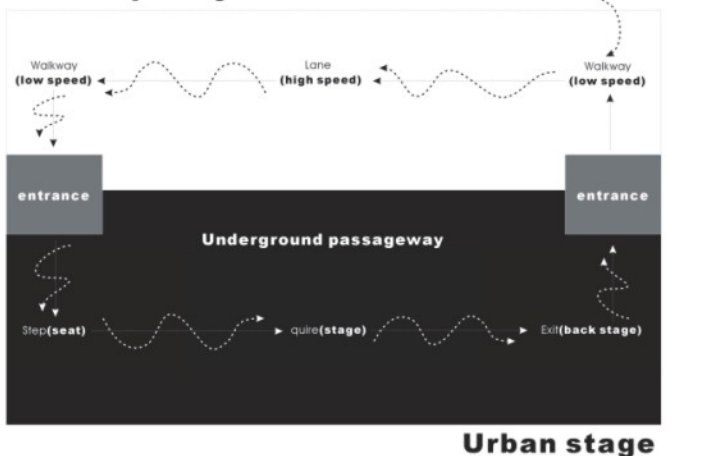

### Urban open system

Interlock  
/ local metamorphism

M 37

運動後的人們隨著自行車網路連接至城市內部網路

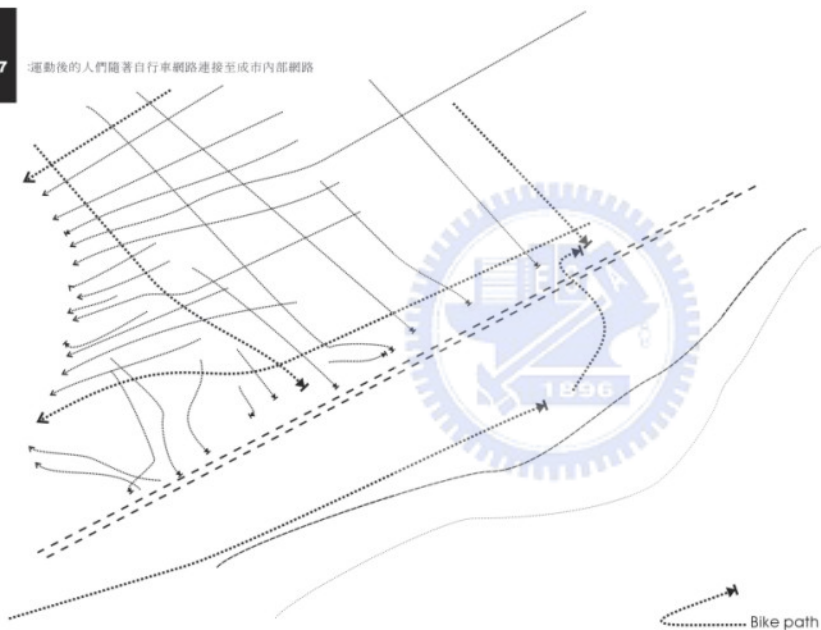

### Bike path

New urban-net  
/ connecting  
/ life style

M 42

隨著都市擴張,MRT跟著成長,帶動未來許多可預期與不可預期的變化

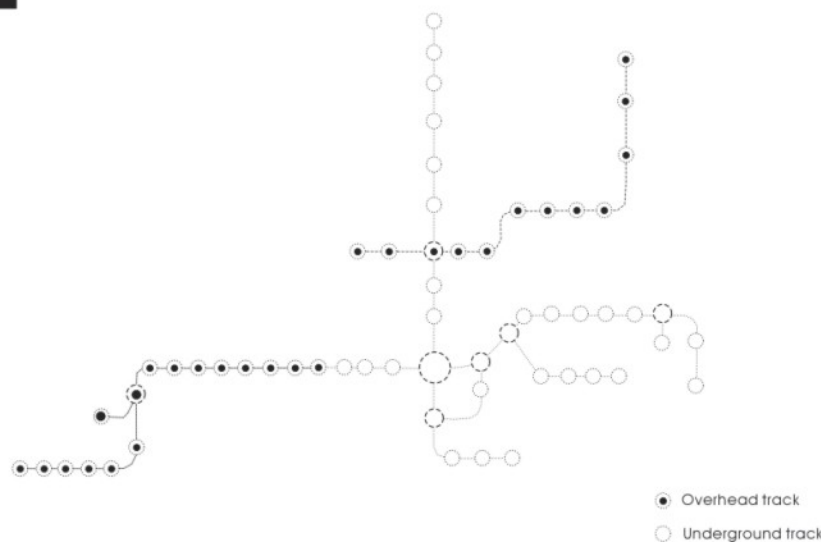

### MRT overhead track

New urban-high level  
/ linear public space  
/ public pollution

[ M37 + M47 ] + M72 = ?

# SKY STADIUM

**BIKE ON THE MRT  
SKY STADIUM**



**AFTER AM:12:00  
RIDE YOUR BIKE TO THE STATION**

**FLYING**

**IN THE URBAN NEW LEVEL**



**MRT idle time**

NEW TIME

Going time

Maintaining time

**AFTER-HOURS**

NEW PURPOSE

Transport

Shop

**SPORT**

NEW USER

Passenger  
(office / student)

Tourist

**OWL**



**night sporty event**

TYPE

Running

Basketball

**Bike**

VIRTURE

Slimming

fresh air

**OWE**

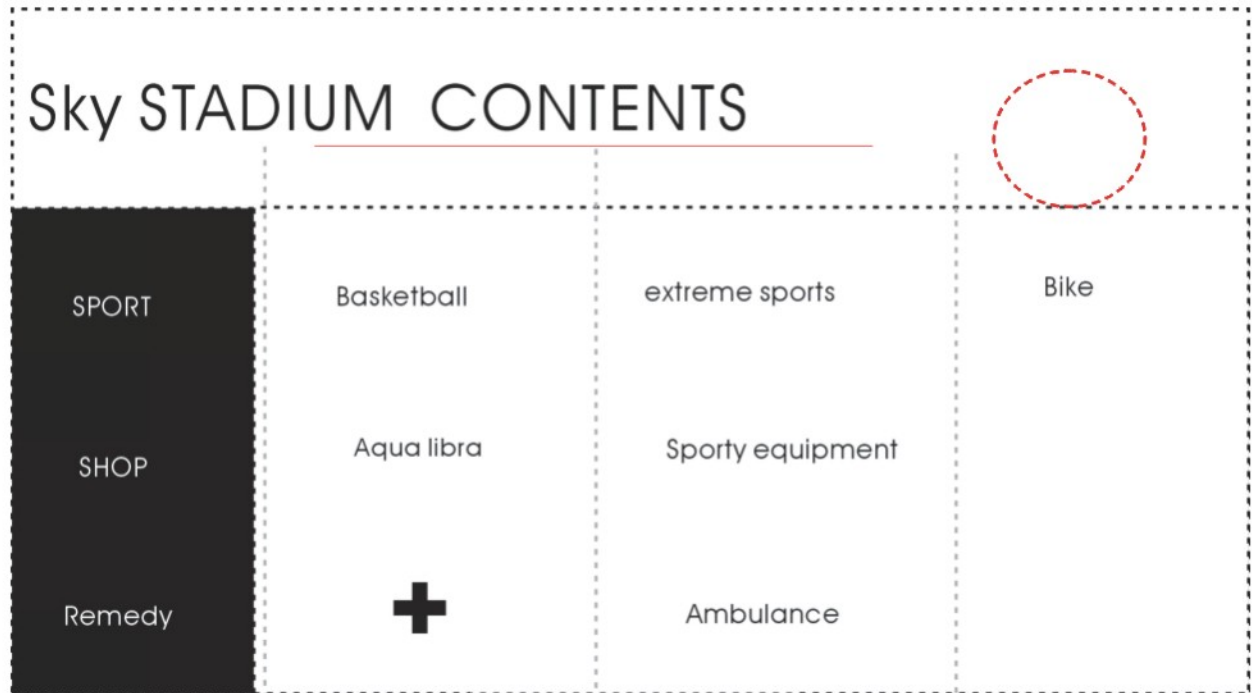

SKY STADIUM  
NEW URBAN SPORTY NET



SPORT

## Urban traffic system

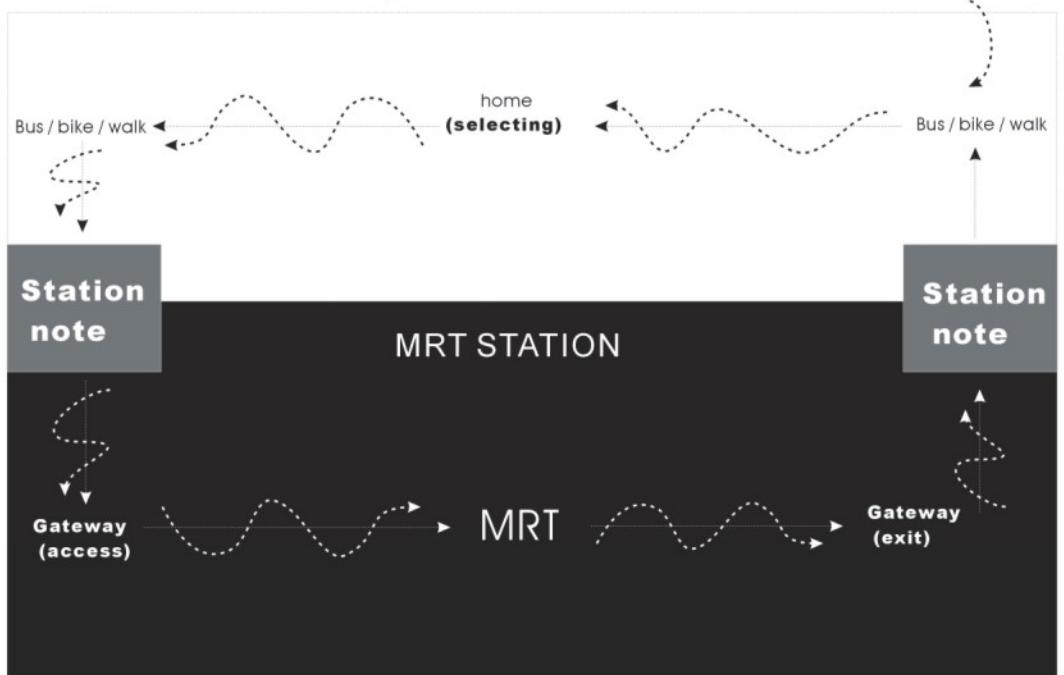

## Urban S. net



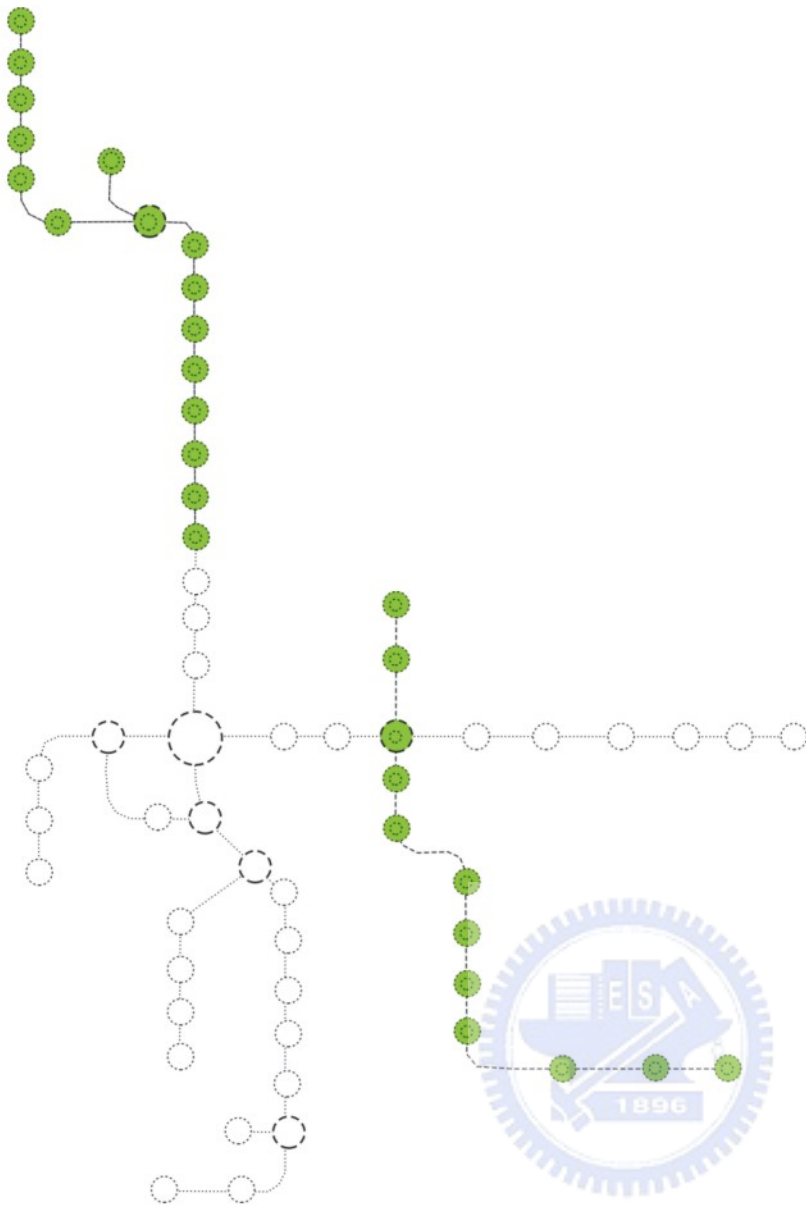

overhead track

Home			
Station note	Different layer		Access
Station SPORT centre			
Tickets		Map location ---> goal	Select track
Gateway			Log in
Platform			Riding
Midpoint			
Platform			Riding
Gateway			Log out
Exit			

tectonics

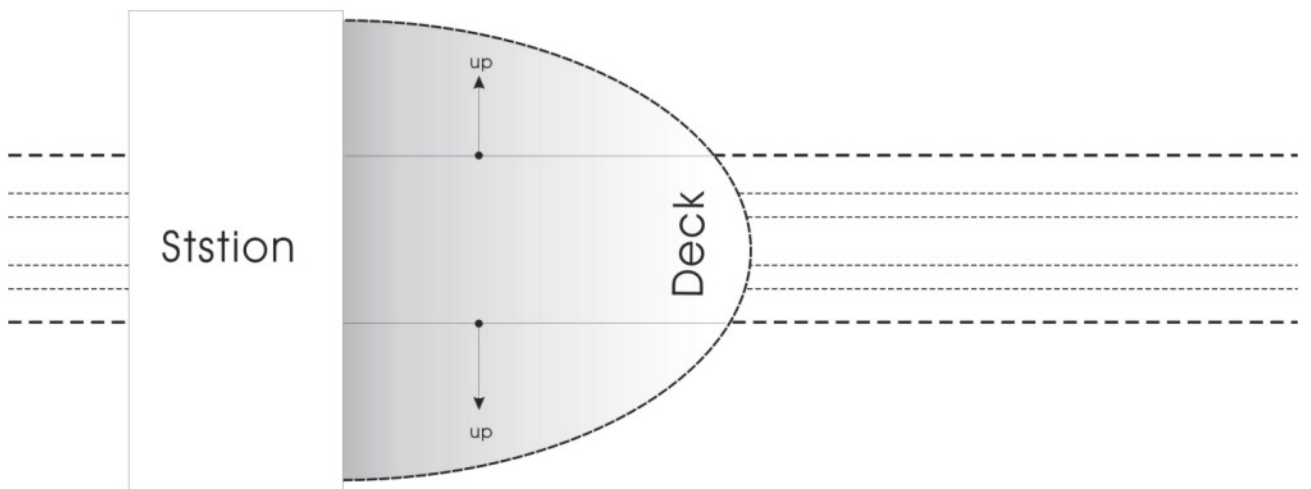
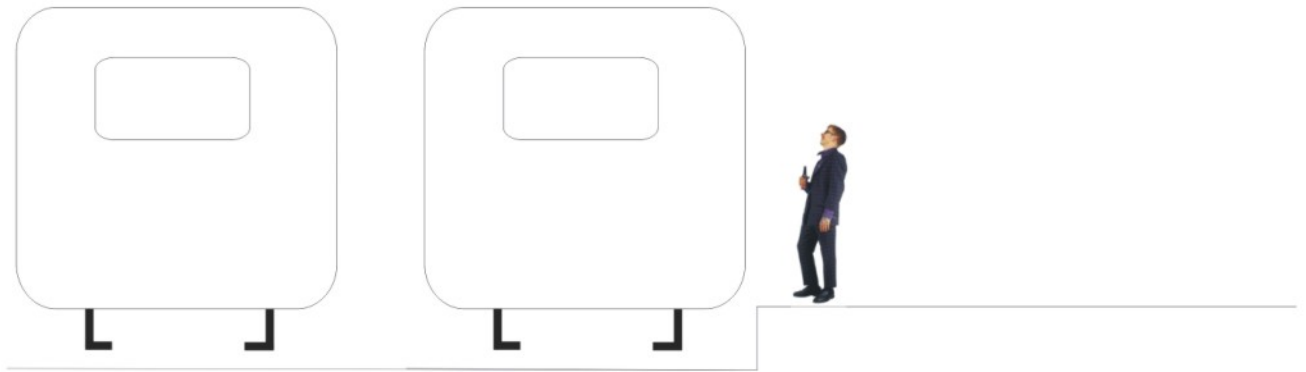



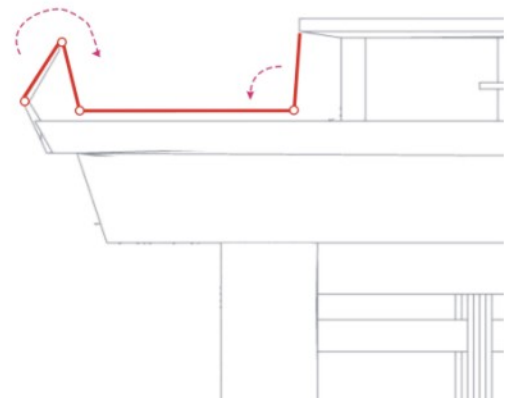
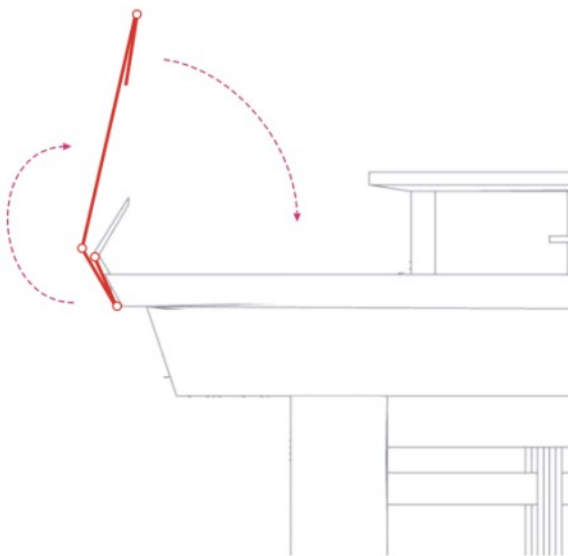
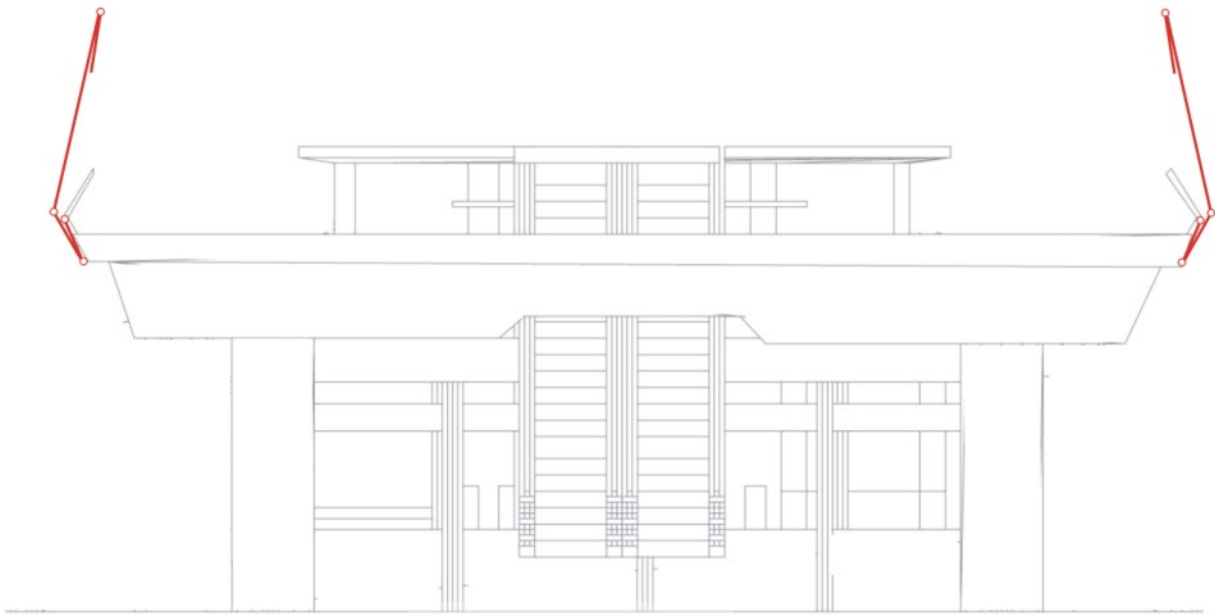

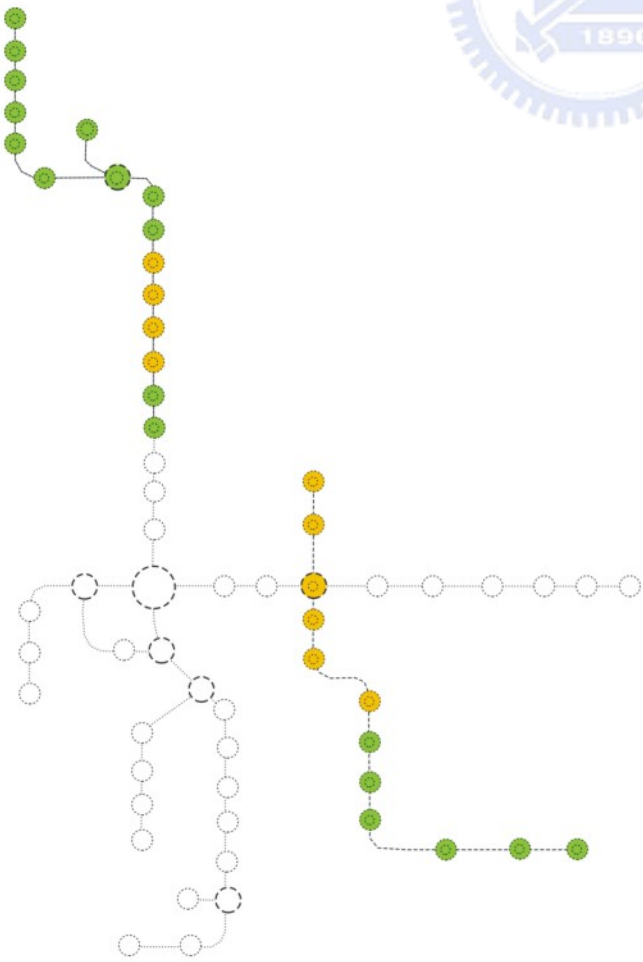
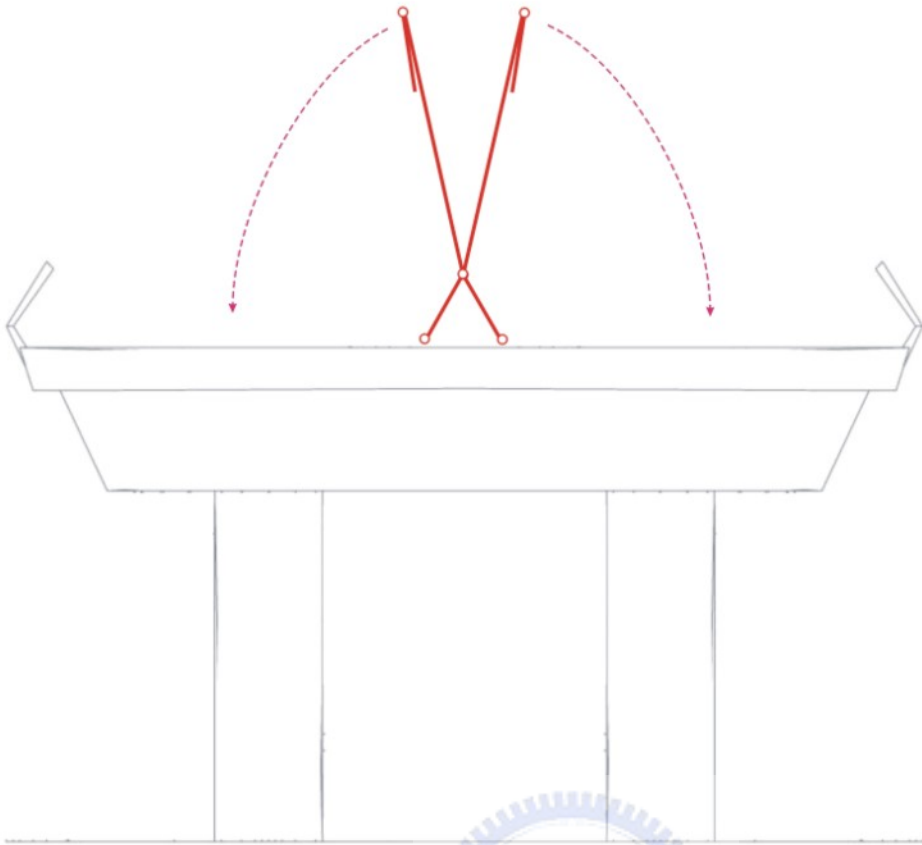

good view--outer city  
 bad view --urban district





**MRT environment-hostile**

visual pollution  
noise pollution  
strong breeze

**organization**

visual pollution  
**noise pollution**  
strong breeze

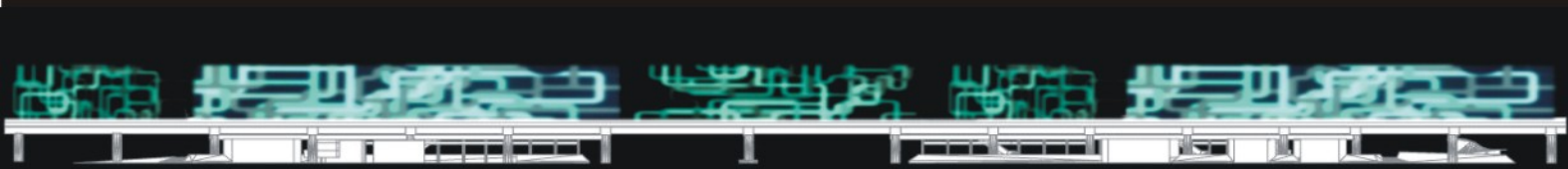

Night--deck / bike track lighting  
Daytime--noiseproof wall / motional media wall

